

NATR 10 PPA SKF

Yoke type track roller

TYPE: Roller bearings, Yoke type track rollers, With axial guidance, Sealing rings on both sides

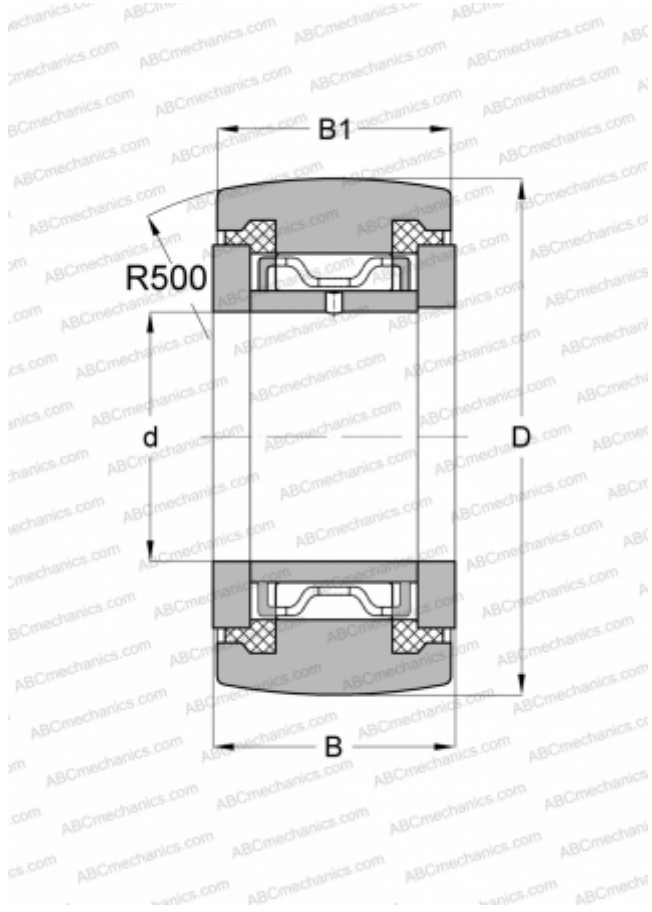

Technical specification

DIMENSIONS, MM

d	10,000
D	30,000
B	15,000
B1	14,000

WEIGHT, KG

0,061

MANUFACTURER

[SKF](#)

INTERCHANGE

ABC	NATR 10 PP
INA	NATR 10 PP
IKO	NART 10 UUR
McGill	MCYRR-10-S

CALCULATION DATA

Basic dynamic load rating, C	6,440 kN
Basic static load rating, Co	8,000 kN
Fatigue load limit, Pu	0,880 kN
Limiting speed	4800 r/min