

NART 10 UUR IKO

Yoke type track roller

TYPE: Roller bearings, Yoke type track rollers, With axial guidance, Sealing rings on both sides

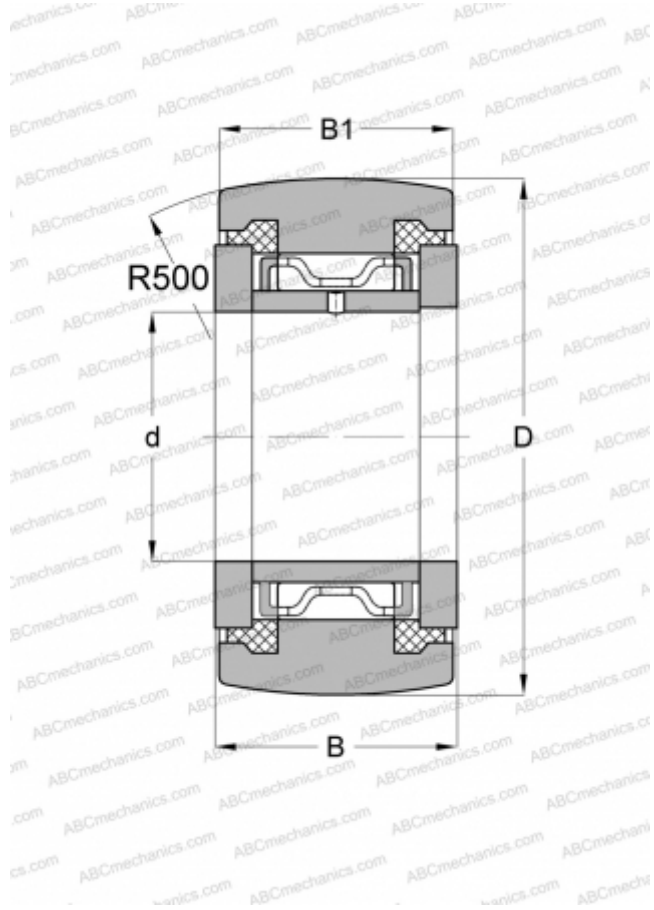

Technical specification

DIMENSIONS, MM

d	10,000
D	30,000
B	15,000
B1	14,000

WEIGHT, KG

0,065

MANUFACTURER

[IKO](#)

INTERCHANGE

ABC	NATR 10 PP
INA	NATR 10 PP
SKF	NATR 10 PPA
McGill	MCYRR-10-S

CALCULATION DATA

Basic dynamic load rating, C	8,030 kN
Basic static load rating, Co	7,540 kN