

NATR 15 PPA SKF

Yoke type track roller

TYPE: Roller bearings, Yoke type track rollers, With axial guidance, Sealing rings on both sides

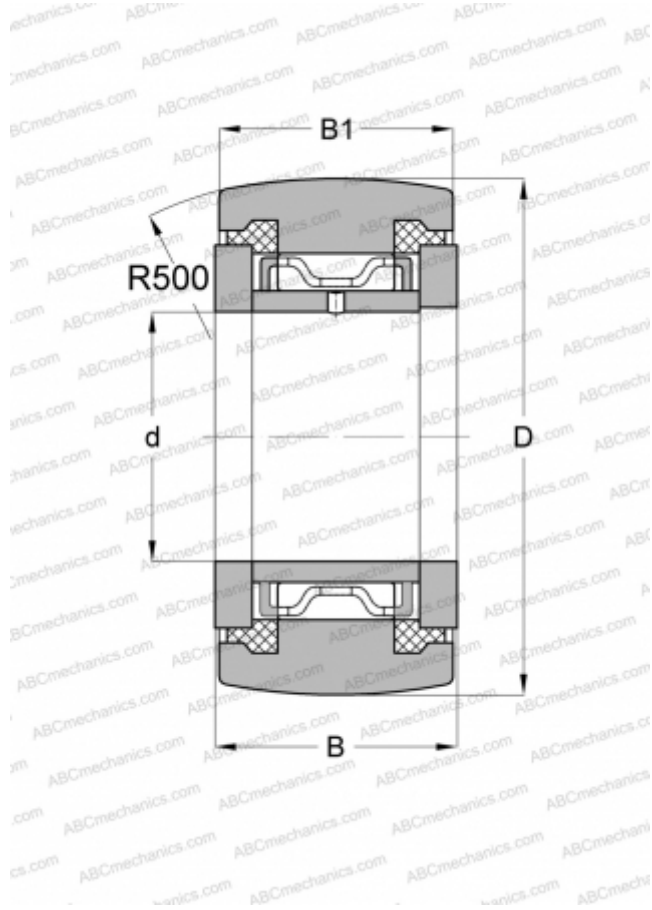

Technical specification

DIMENSIONS, MM

d	15,000
D	35,000
B	19,000
B1	18,000

WEIGHT, KG

0,095

MANUFACTURER

[SKF](#)

INTERCHANGE

ABC	NATR 15 PP
INA	NATR 15 PP
IKO	NART 15 UUR
McGill	MCYRR-15-S

CALCULATION DATA

Basic dynamic load rating, C	9,520 kN
Basic static load rating, Co	13,700 kN
Fatigue load limit, Pu	1,560 kN
Limiting speed	4000 r/min