

NART 20 UUR IKO

Yoke type track roller

TYPE: Roller bearings, Yoke type track rollers, With axial guidance, Sealing rings on both sides

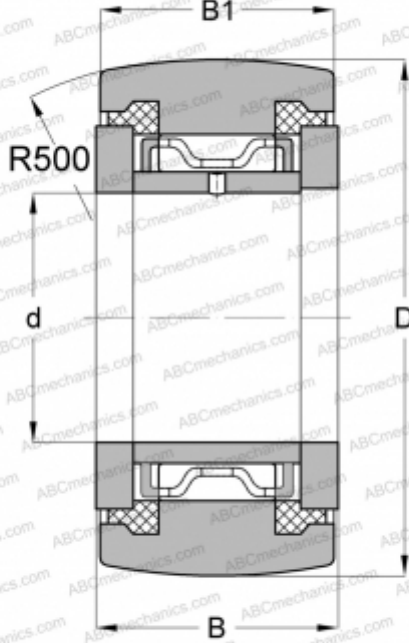

Technical specification

DIMENSIONS, MM

d	20,000
D	47,000
B	25,000
B1	24,000

WEIGHT, KG

0,250

MANUFACTURER

[IKO](#)

INTERCHANGE

ABC	NATR 20 PP
INA	NATR 20 PP
SKF	NATR 20 PPA
McGill	MCYRR-20-S

CALCULATION DATA

Basic dynamic load rating, C	23,000 kN
Basic static load rating, Co	30,700 kN