

## NURT 15 R IKO

Yoke type track roller

TYPE: Roller bearings, Yoke type track rollers, With axial guidance, Full complement cylindrical roller set, labyrinth seals on both sides

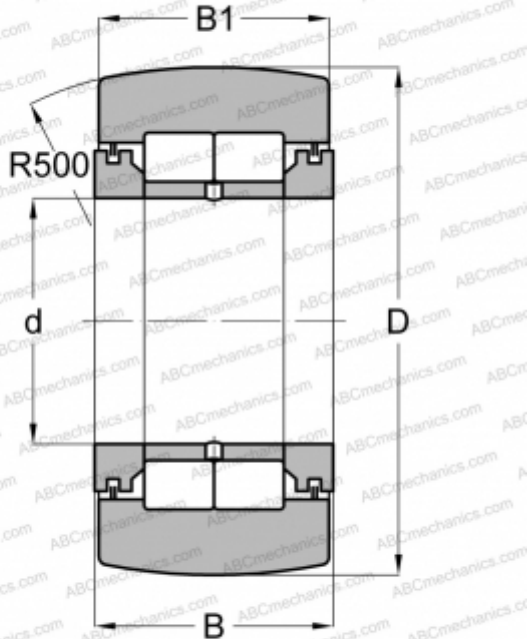

### Technical specification

#### DIMENSIONS, MM

d	15,000
D	35,000
B	19,000
B1	18,000

#### WEIGHT, KG

0,100

#### MANUFACTURER

[IKO](#)

#### INTERCHANGE

ABC	<a href="#">NUTR 15</a>
FAG	<a href="#">NUTR 15(NUTD 15)</a>
INA	<a href="#">NUTR 15</a>
SKF	<a href="#">NUTR 15 A</a>
McGill	<a href="#">MCYRD-15</a>

#### CALCULATION DATA

Basic dynamic load rating, C	23,400 kN
Basic static load rating, Co	27,300 kN