

## NURT 25 R IKO

Yoke type track roller

TYPE: Roller bearings, Yoke type track rollers, With axial guidance, Full complement cylindrical roller set, labyrinth seals on both sides

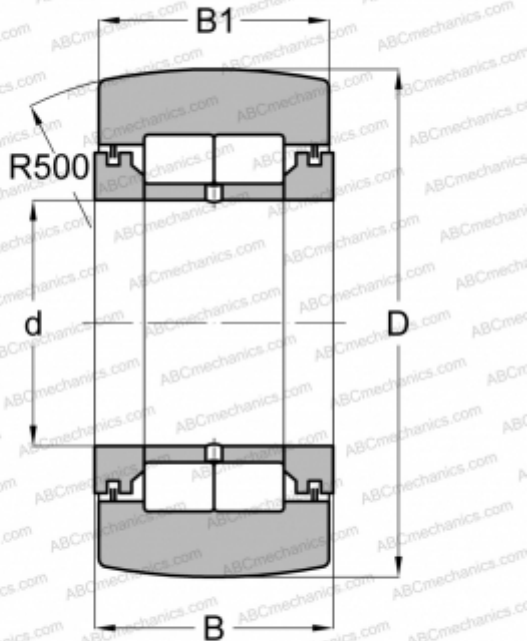

### Technical specification

#### DIMENSIONS, MM

d	25,000
D	52,000
B	25,000
B1	24,000

#### WEIGHT, KG

0,281

#### MANUFACTURER

[IKO](#)

#### INTERCHANGE

ABC	<a href="#">NUTR 25</a>
FAG	<a href="#">NUTR 25(NUTD 25)</a>
INA	<a href="#">NUTR 25</a>
SKF	<a href="#">NUTR 25 A</a>
McGill	<a href="#">MCYRD-25</a>

#### CALCULATION DATA

Basic dynamic load rating, C	43,100 kN
Basic static load rating, Co	58,100 kN