

## NURT 30 R IKO

Yoke type track roller

TYPE: Roller bearings, Yoke type track rollers, With axial guidance, Full complement cylindrical roller set, labyrinth seals on both sides

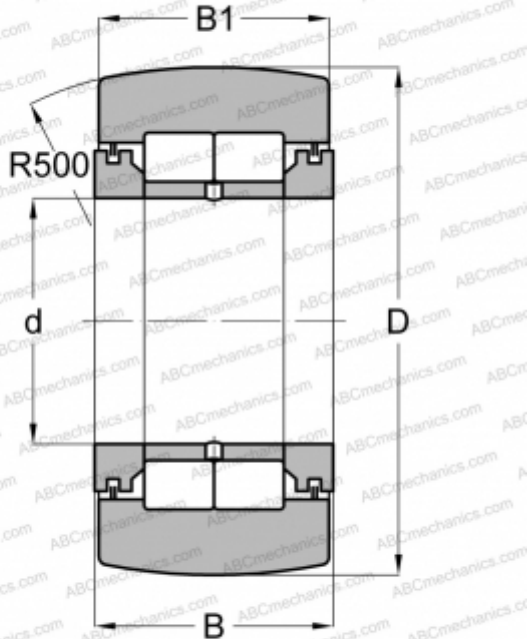

### Technical specification

#### DIMENSIONS, MM

d	30,000
D	62,000
B	29,000
B1	28,000

#### WEIGHT, KG

0,466

#### MANUFACTURER

[IKO](#)

#### INTERCHANGE

ABC	<a href="#">NUTR 30</a>
FAG	<a href="#">NUTR 30(NUTD 30)</a>
INA	<a href="#">NUTR 30</a>
SKF	<a href="#">NUTR 30 A</a>
McGill	<a href="#">MCYRD-30</a>

#### CALCULATION DATA

Basic dynamic load rating, C	58,200 kN
Basic static load rating, Co	75,300 kN