

## NURT 35 R IKO

Yoke type track roller

TYPE: Roller bearings, Yoke type track rollers, With axial guidance, Full complement cylindrical roller set, labyrinth seals on both sides

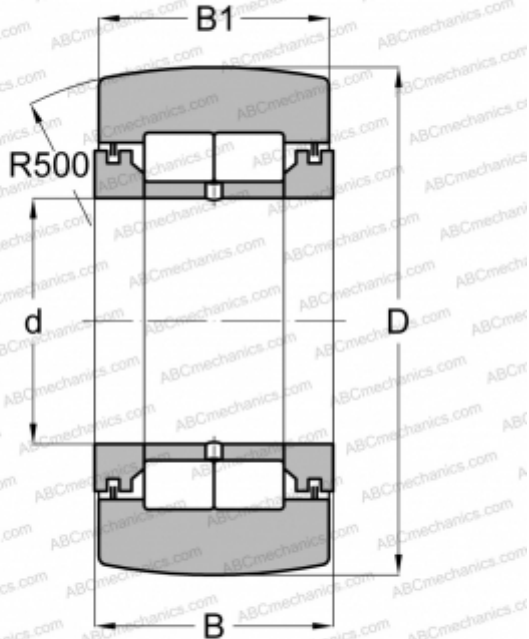

### Technical specification

#### DIMENSIONS, MM

d	35,000
D	72,000
B	29,000
B1	28,000

#### WEIGHT, KG

0,630

#### MANUFACTURER

[IKO](#)

#### INTERCHANGE

ABC	<a href="#">NUTR 35</a>
FAG	<a href="#">NUTR 35(NUTD 35)</a>
INA	<a href="#">NUTR 35</a>
SKF	<a href="#">NUTR 35 A</a>
McGill	<a href="#">MCYRD-35</a>

#### CALCULATION DATA

Basic dynamic load rating, C	63,900 kN
Basic static load rating, Co	88,800 kN