

NURT 45 R IKO

Yoke type track roller

TYPE: Roller bearings, Yoke type track rollers, With axial guidance, Full complement cylindrical roller set, labyrinth seals on both sides

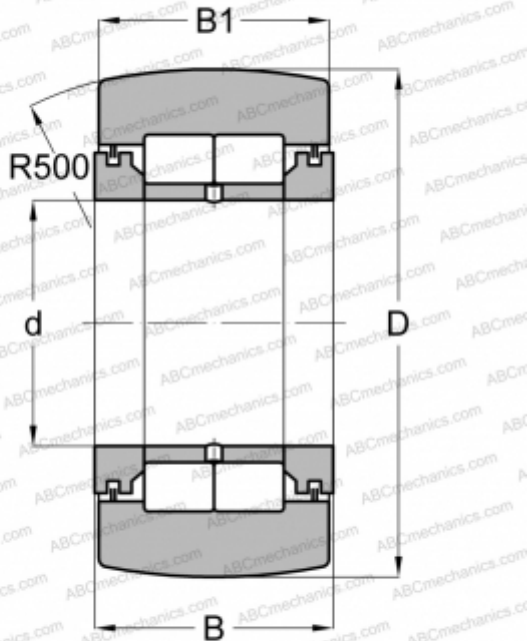

Technical specification

DIMENSIONS, MM

d	45,000
D	85,000
B	32,000
B1	30,000

WEIGHT, KG

0,883

MANUFACTURER

[IKO](#)

INTERCHANGE

ABC	NUTR 45
FAG	NUTR 45(NUTD 45)
INA	NUTR 45
SKF	NUTR 45 A
McGill	MCYRD-45

CALCULATION DATA

Basic dynamic load rating, C	91,500 kN
Basic static load rating, Co	135,000 kN