

CRY 14 V ABC

Yoke type track roller

TYPE: Roller bearings, Yoke type track rollers, With axial guidance, Full complement needle roller set, gap seals on both sides, cylindrical outer ring, inch size

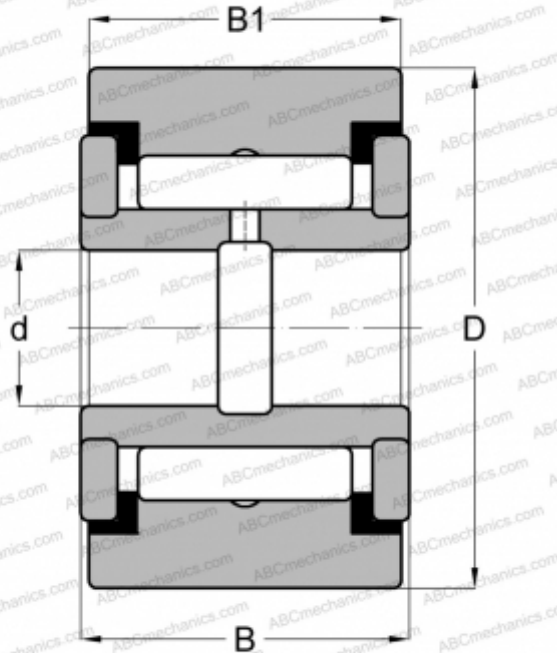

Technical specification

DIMENSIONS, MM

d	6,350
D	22,225
B	14,288
B1	12,700

WEIGHT, KG

0,036

MANUFACTURER

[ABC](#)

INTERCHANGE

IKO	CRY 14 V
McGill	CVR 7/8