

CYR 1 1/8 McGill

Yoke type track roller

TYPE: Roller bearings, Yoke type track rollers, With axial guidance, Full complement needle roller set, gap seals on both sides, cylindrical outer ring, inch size

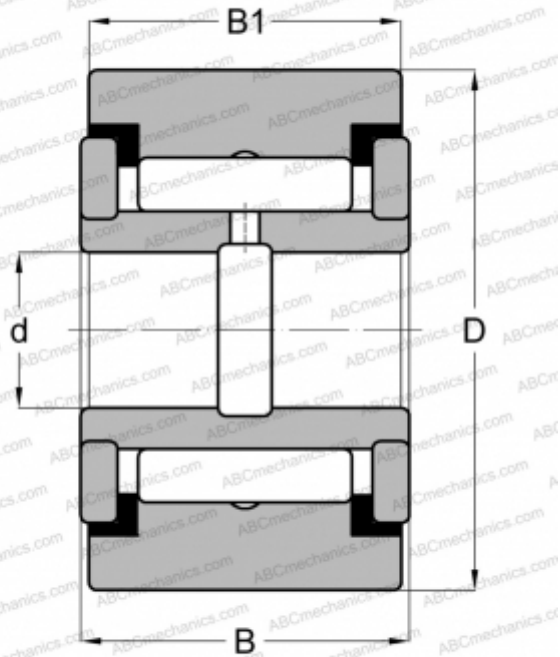

Technical specification

DIMENSIONS, MM

d	9,938
D	28,575
B	17,463
B1	15,875

WEIGHT, KG

0,077

MANUFACTURER

[McGill](#)

INTERCHANGE

ABC	CRY 18 V
IKO	CRY 18 V