

CYR 1 1/4 McGill

Yoke type track roller

TYPE: Roller bearings, Yoke type track rollers, With axial guidance, Full complement needle roller set, gap seals on both sides, cylindrical outer ring, inch size

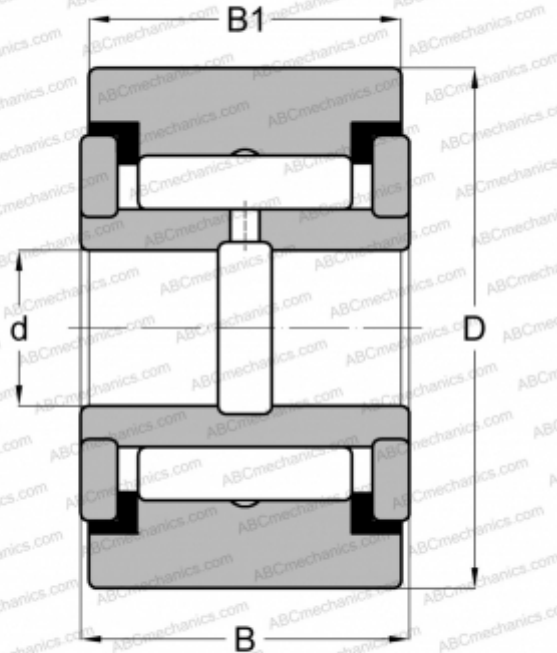

Technical specification

DIMENSIONS, MM

d	9,525
D	31,750
B	20,638
B1	19,050

WEIGHT, KG

0,109

MANUFACTURER

[McGill](#)

INTERCHANGE

ABC	CRY 20 V
IKO	CRY 20 V