

CRY 26 V ABC

Yoke type track roller

TYPE: Roller bearings, Yoke type track rollers, With axial guidance, Full complement needle roller set, gap seals on both sides, cylindrical outer ring, inch size

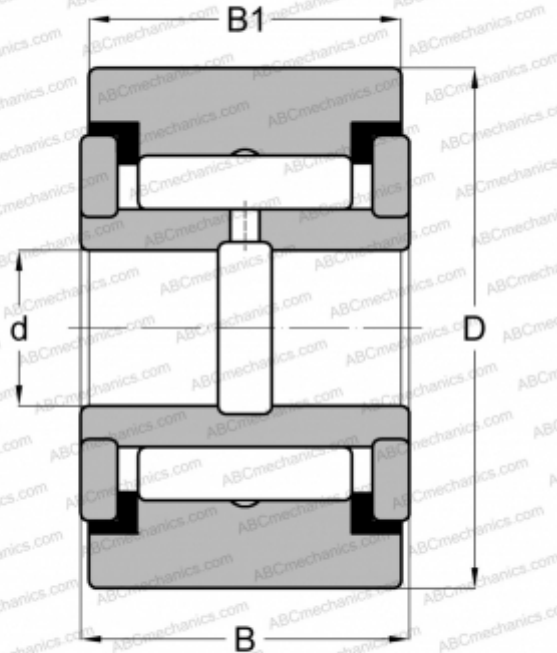

Technical specification

DIMENSIONS, MM

d	11,112
D	41,275
B	23,813
B1	22,225

WEIGHT, KG

0,227

MANUFACTURER

[ABC](#)

INTERCHANGE

IKO	CRY 26 V
McGill	CVR 1 5/8