

CRY 30 V ABC

Yoke type track roller

TYPE: Roller bearings, Yoke type track rollers, With axial guidance, Full complement needle roller set, gap seals on both sides, cylindrical outer ring, inch size

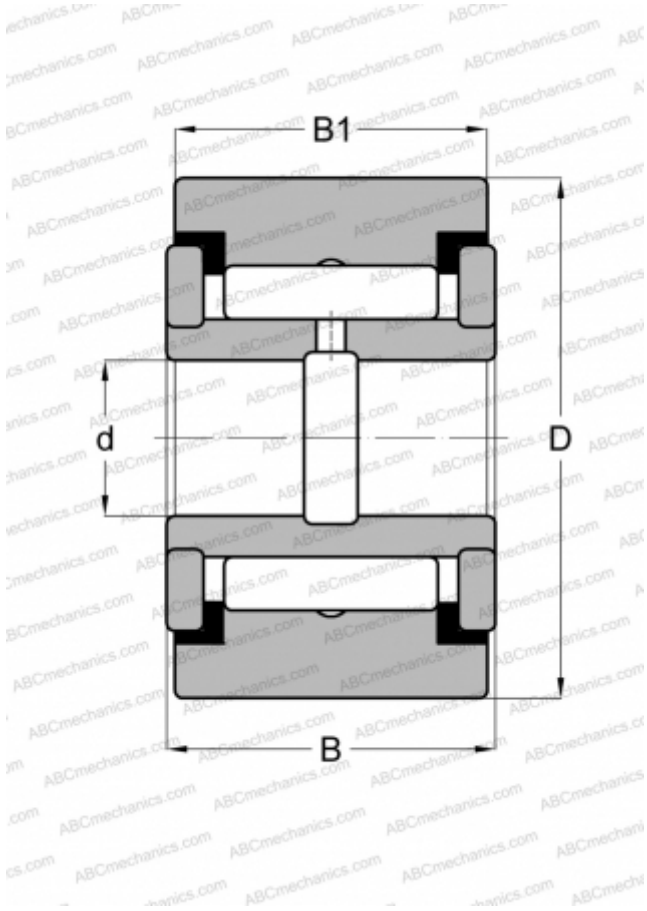

Technical specification

DIMENSIONS, MM

d	12,700
D	47,625
B	26,988
B1	25,400

WEIGHT, KG

0,363

MANUFACTURER

[ABC](#)

INTERCHANGE

IKO	CRY 30 V
McGill	CVR 1 7/8