

CRY 32 V ABC

Yoke type track roller

TYPE: Roller bearings, Yoke type track rollers, With axial guidance, Full complement needle roller set, gap seals on both sides, cylindrical outer ring, inch size

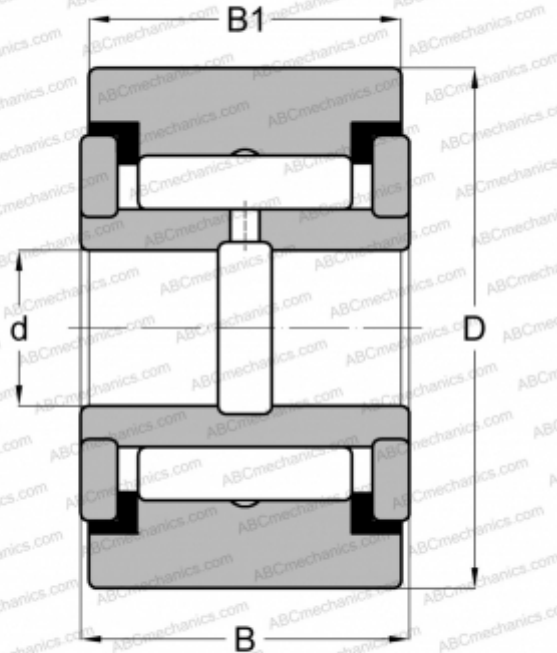

Technical specification

DIMENSIONS, MM

d	15,875
D	50,800
B	33,338
B1	31,750

WEIGHT, KG

0,476

MANUFACTURER

[ABC](#)

INTERCHANGE

IKO	CRY 32 V
McGill	CVR 2