

CYR 2 1/2 McGill

Yoke type track roller

TYPE: Roller bearings, Yoke type track rollers, With axial guidance, Full complement needle roller set, gap seals on both sides, cylindrical outer ring, inch size

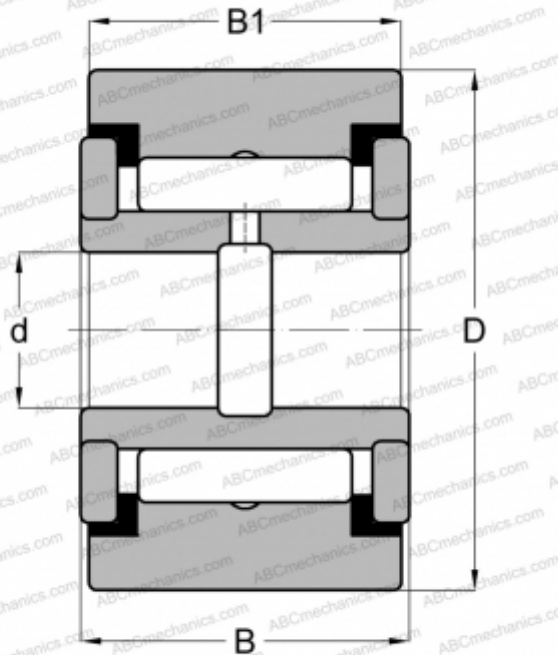

Technical specification

DIMENSIONS, MM

d	19,050
D	63,500
B	39,688
B1	38,100

WEIGHT, KG

0,816

MANUFACTURER

[McGill](#)

INTERCHANGE

ABC	CRY 40 V
IKO	CRY 40 V