

## CRY 44 V IKO

Yoke type track roller

TYPE: Roller bearings, Yoke type track rollers, With axial guidance, Full complement needle roller set, gap seals on both sides, cylindrical outer ring, inch size

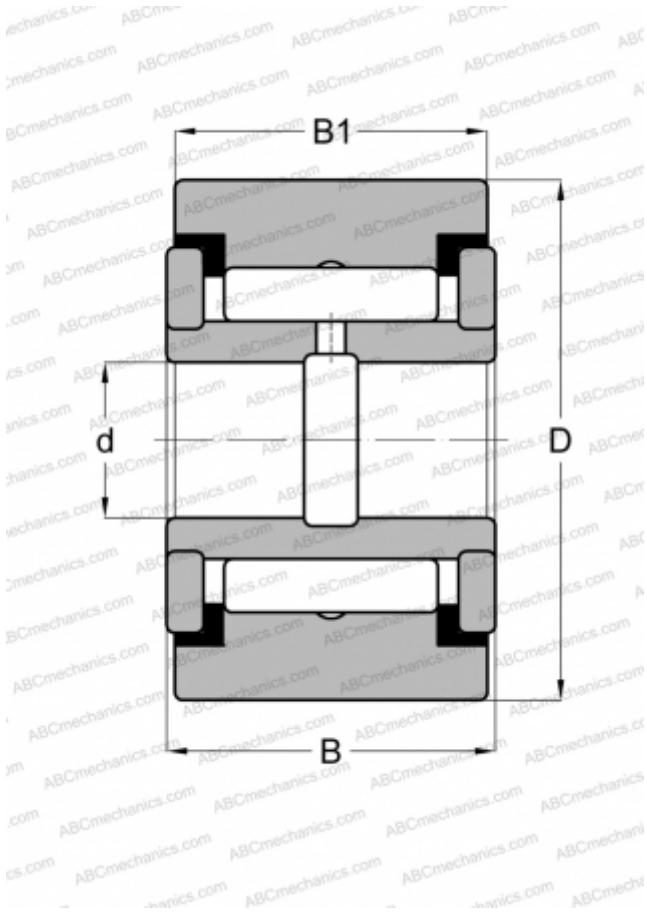

### Technical specification

#### DIMENSIONS, MM

d	19,050
D	69,850
B	39,688
B1	38,100

#### WEIGHT, KG

1,020

#### MANUFACTURER

[IKO](#)

#### INTERCHANGE

ABC	<a href="#">CRY 44 V</a>
McGill	<a href="#">CYR 2 3/4</a>

#### CALCULATION DATA

Basic dynamic load rating, C	61,400 kN
Basic static load rating, Co	116,000 kN