

CRY 48 V ABC

Yoke type track roller

TYPE: Roller bearings, Yoke type track rollers, With axial guidance, Full complement needle roller set, gap seals on both sides, cylindrical outer ring, inch size

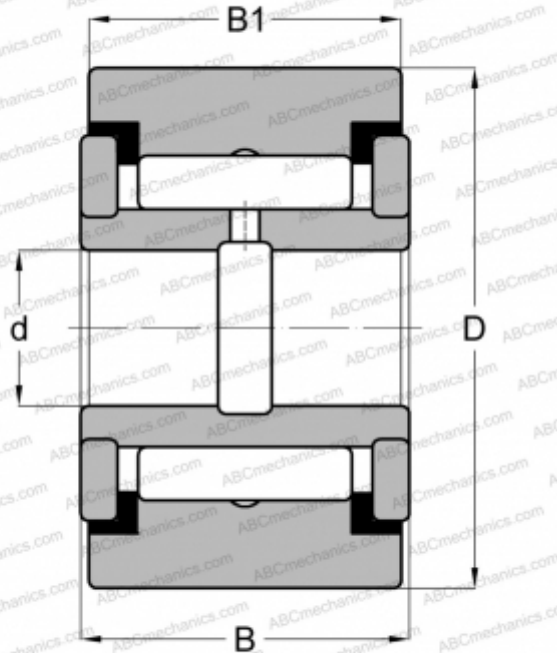

Technical specification

DIMENSIONS, MM

d	25,400
D	76,200
B	46,038
B1	44,450

WEIGHT, KG

1,410

MANUFACTURER

[ABC](#)

INTERCHANGE

IKO	CRY 48 V
McGill	CVR 3