

CYR 3 1/4 McGill

Yoke type track roller

TYPE: Roller bearings, Yoke type track rollers, With axial guidance, Full complement needle roller set, gap seals on both sides, cylindrical outer ring, inch size

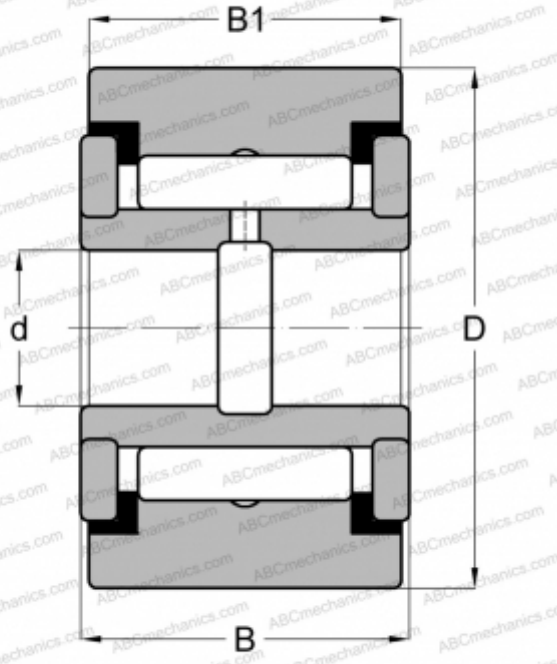

Technical specification

DIMENSIONS, MM

d	25,400
D	82,550
B	46,038
B1	44,450

WEIGHT, KG

1,640

MANUFACTURER

[McGill](#)

INTERCHANGE

ABC	CRY 52 V
IKO	CRY 52 V