

CRY 56 V ABC

Yoke type track roller

TYPE: Roller bearings, Yoke type track rollers, With axial guidance, Full complement needle roller set, gap seals on both sides, cylindrical outer ring, inch size

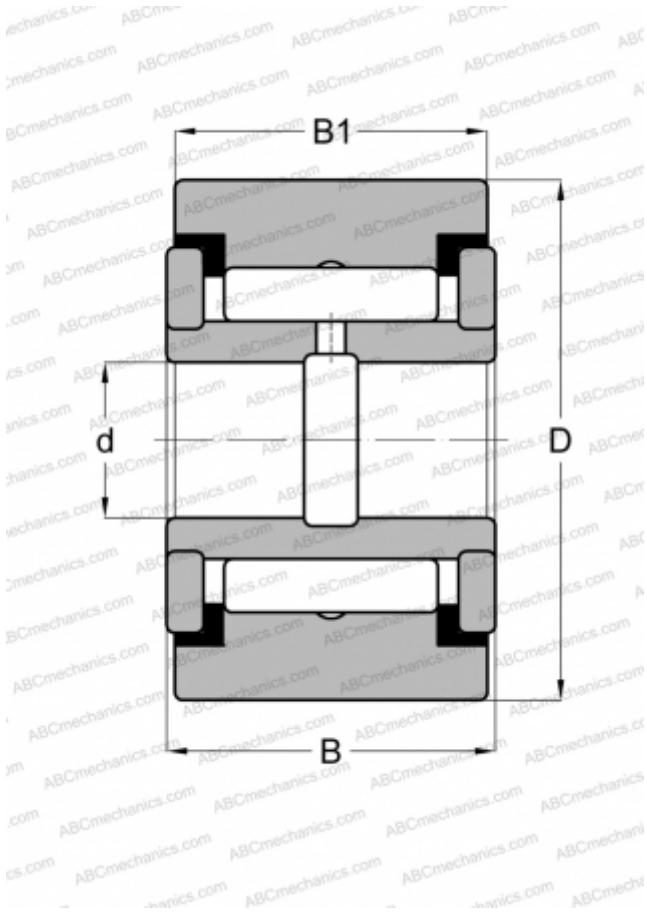

Technical specification

DIMENSIONS, MM

d	28,575
D	88,900
B	52,388
B1	50,800

WEIGHT, KG

2,250

MANUFACTURER

[ABC](#)

INTERCHANGE

IKO	CRY 56 V
McGill	CVR 3 1/2