

CRY 14 VR IKO

Yoke type track roller

TYPE: Roller bearings, Yoke type track rollers, With axial guidance, Full complement needle roller set, gap seals on both sides, inch size

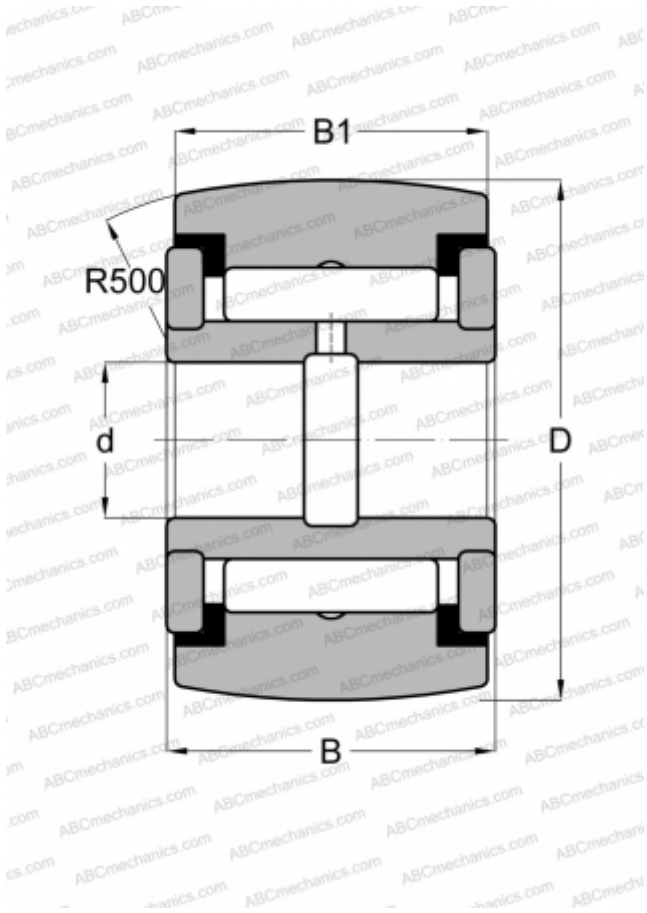

Technical specification

DIMENSIONS, MM

d	6,350
D	22,225
B	14,288
B1	12,700

MANUFACTURER

[IKO](#)

INTERCHANGE

ABC	CRY 14 VR
McGill	CCYR 7/8

CALCULATION DATA

Basic dynamic load rating, C	8,710 kN
Basic static load rating, Co	12,300 kN