

CRY 14 VUU IKO

Yoke type track roller

TYPE: Roller bearings, Yoke type track rollers, With axial guidance, Full complement needle roller set, sealing rings on both sides, cylindrical outer ring, inch size

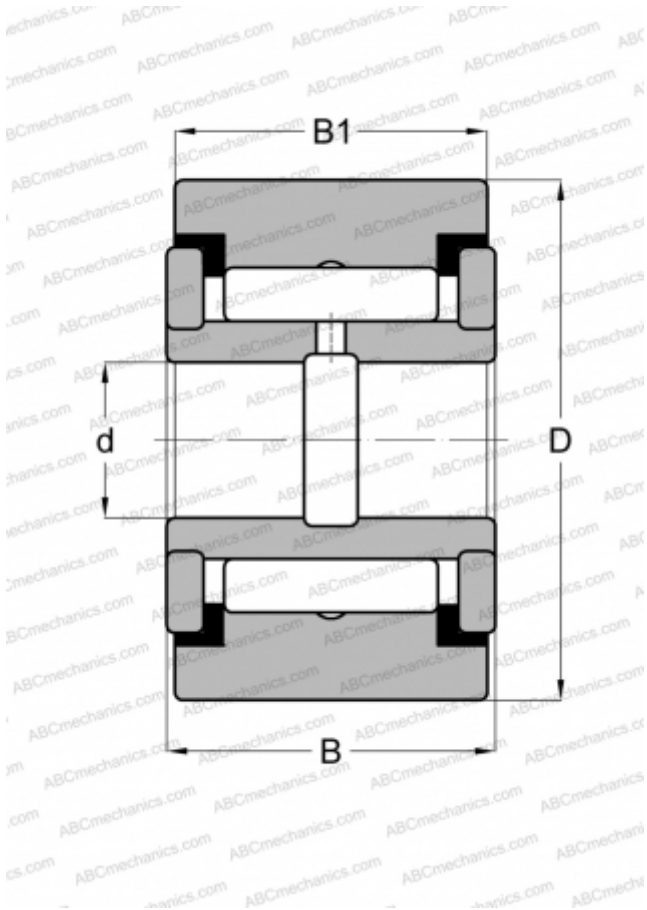

Technical specification

DIMENSIONS, MM

d	6,350
D	22,225
B	14,288
B1	12,700

WEIGHT, KG

0,036

MANUFACTURER

[IKO](#)

INTERCHANGE

ABC	YCRS 14
INA	RF 14 PP
McGill	CYR 7/8 S
RBC	Y 28 L
SKF	YR 7/8 X
TORRINGTON	YCRS 14

CALCULATION DATA

Basic dynamic load rating, C	8,710 kN
Basic static load rating, Co	12,300 kN