

YR 1 X SKF

Yoke type track roller

TYPE: Roller bearings, Yoke type track rollers, With axial guidance, Full complement needle roller set, sealing rings on both sides, cylindrical outer ring, inch size

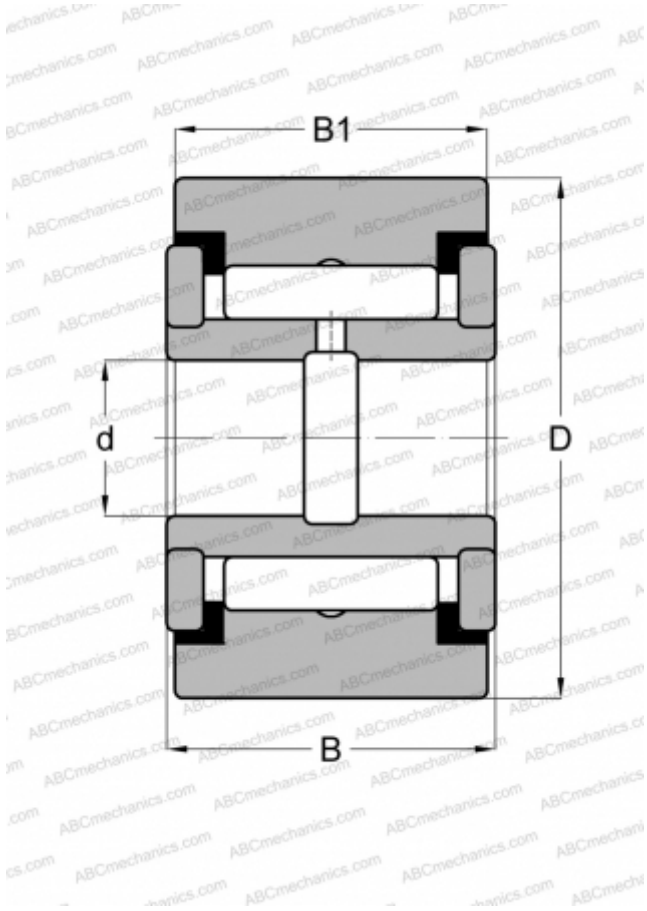

Technical specification

DIMENSIONS, MM

d	7,938
D	25,400
B	17,463
B1	15,875

WEIGHT, KG

0,068

MANUFACTURER

[SKF](#)

INTERCHANGE

ABC	YCRS 16
INA	RF 16 PP
McGill	CYR 1 S
RBC	Y 32 L
TORRINGTON	YCRS 16
IKO	CRY 16 VUU