

YCRS 18 TORRINGTON

Yoke type track roller

TYPE: Roller bearings, Yoke type track rollers, With axial guidance, Full complement needle roller set, sealing rings on both sides, cylindrical outer ring, inch size

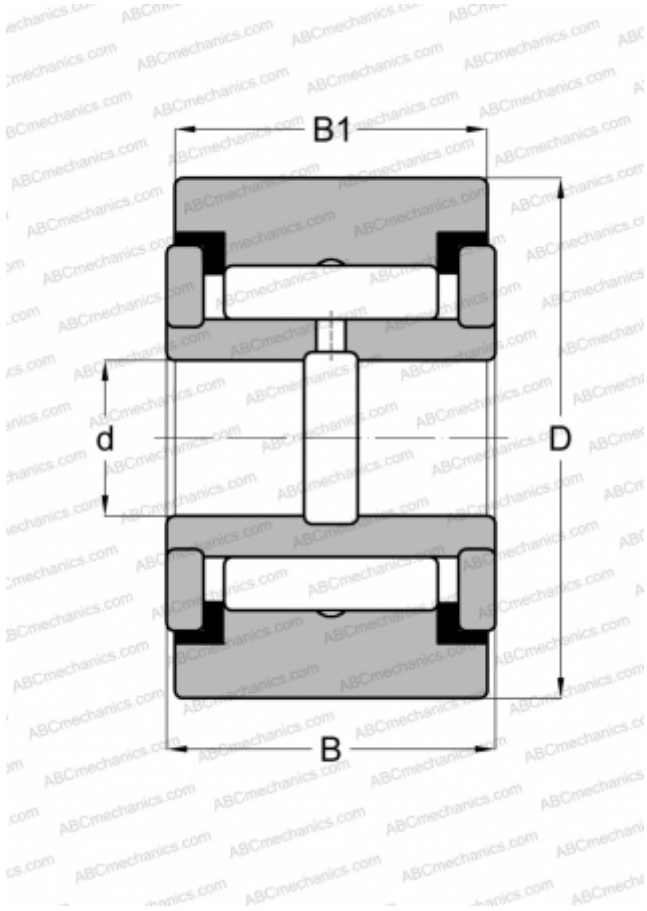

Technical specification

DIMENSIONS, MM

d	7,938
D	28,575
B	17,463
B1	15,875

WEIGHT, KG

0,077

MANUFACTURER

[TORRINGTON](#)

INTERCHANGE

ABC	YCRS 18
INA	RF 18 PP
McGill	CYR 1 1/8 S
RBC	Y 36 L
SKF	YR 1 1/8 X
IKO	CRY 18 VUU