

CRY 22 VUU IKO

Yoke type track roller

TYPE: Roller bearings, Yoke type track rollers, With axial guidance, Full complement needle roller set, sealing rings on both sides, cylindrical outer ring, inch size

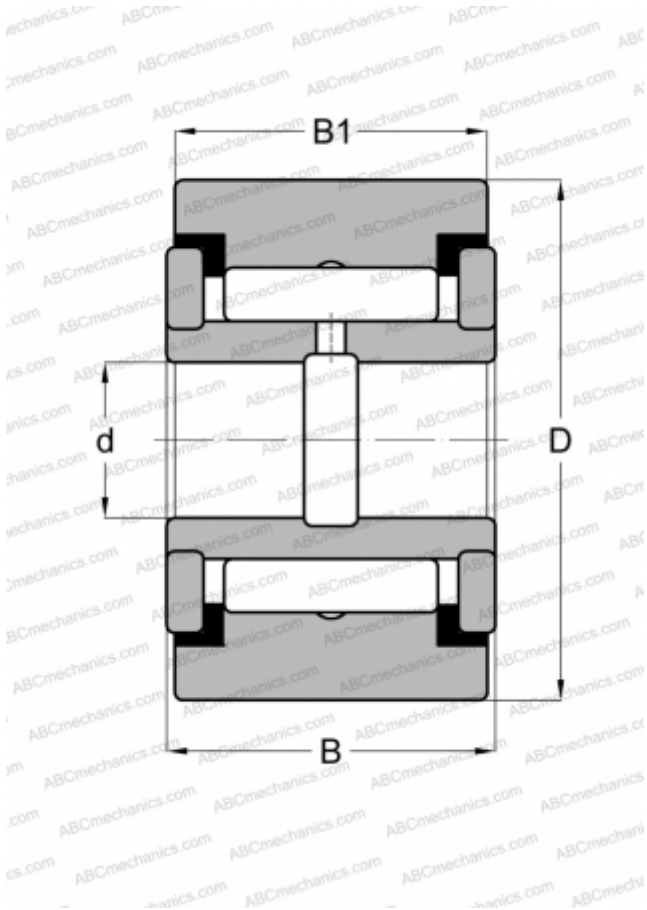

Technical specification

DIMENSIONS, MM

d	9,525
D	34,925
B	20,638
B1	19,050

WEIGHT, KG

0,136

MANUFACTURER

[IKO](#)

INTERCHANGE

ABC	YCRS 22
INA	RF 22 PP
McGill	CYR 1 3/8 S
RBC	Y 44 L
SKF	YR 1 3/8 X
TORRINGTON	YCRS 22

CALCULATION DATA

Basic dynamic load rating, C	23,600 kN
Basic static load rating, Co	31,700 kN