

CRY 24 VUU IKO

Yoke type track roller

TYPE: Roller bearings, Yoke type track rollers, With axial guidance, Full complement needle roller set, sealing rings on both sides, cylindrical outer ring, inch size

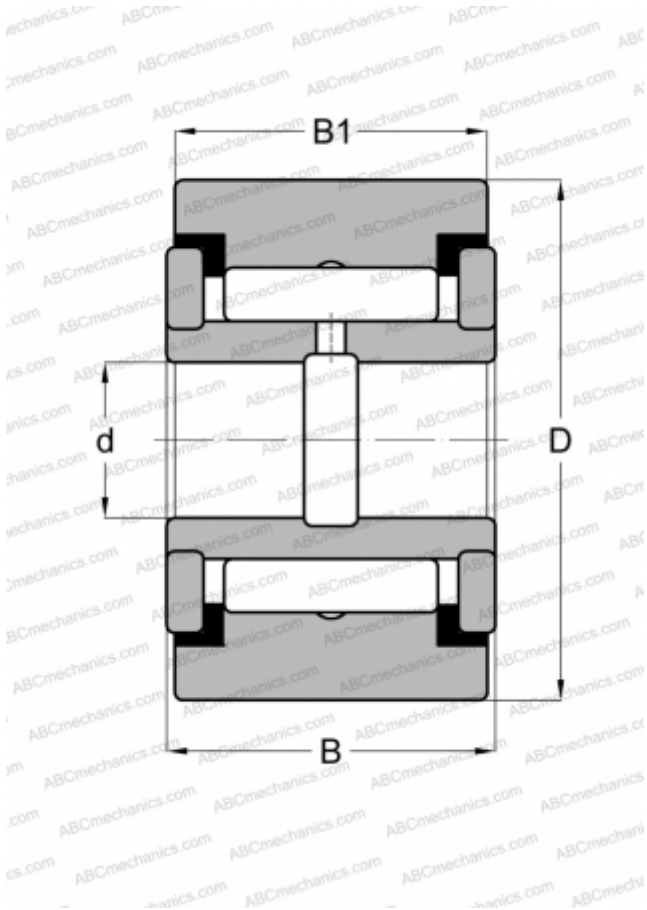

Technical specification

DIMENSIONS, MM

d	11,112
D	38,100
B	23,813
B1	22,225

WEIGHT, KG

0,186

MANUFACTURER

[IKO](#)

INTERCHANGE

ABC	YCRS 24
INA	RF 24 PP
McGill	CYR 1 1/2 S
RBC	Y 48 L
SKF	YR 1 1/2 X
TORRINGTON	YCRS 24

CALCULATION DATA

Basic dynamic load rating, C	28,200 kN
Basic static load rating, Co	40,100 kN