

CRY 28 VUU IKO

Yoke type track roller

TYPE: Roller bearings, Yoke type track rollers, With axial guidance, Full complement needle roller set, sealing rings on both sides, cylindrical outer ring, inch size

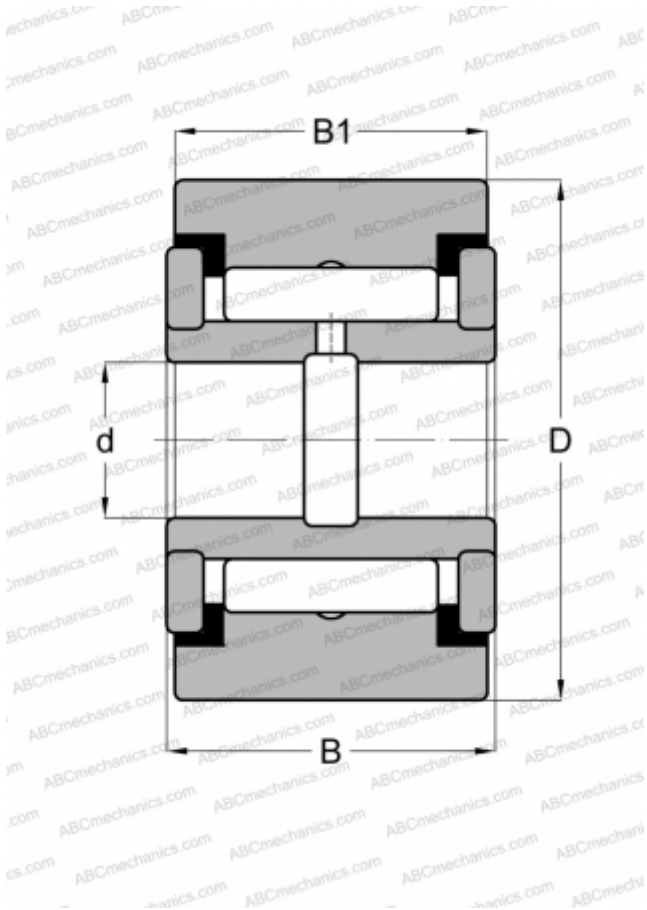

Technical specification

DIMENSIONS, MM

d	12,700
D	44,450
B	26,988
B1	25,400

WEIGHT, KG

0,290

MANUFACTURER

[IKO](#)

INTERCHANGE

ABC	YCRS 28
INA	RF 28 PP
McGill	CYR 1 3/4 S
RBC	Y 56 L
SKF	YR 1 3/4 X
TORRINGTON	YCRS 28

CALCULATION DATA

Basic dynamic load rating, C	35,300 kN
Basic static load rating, Co	55,600 kN