

CRY 32 VUU IKO

Yoke type track roller

TYPE: Roller bearings, Yoke type track rollers, With axial guidance, Full complement needle roller set, sealing rings on both sides, cylindrical outer ring, inch size

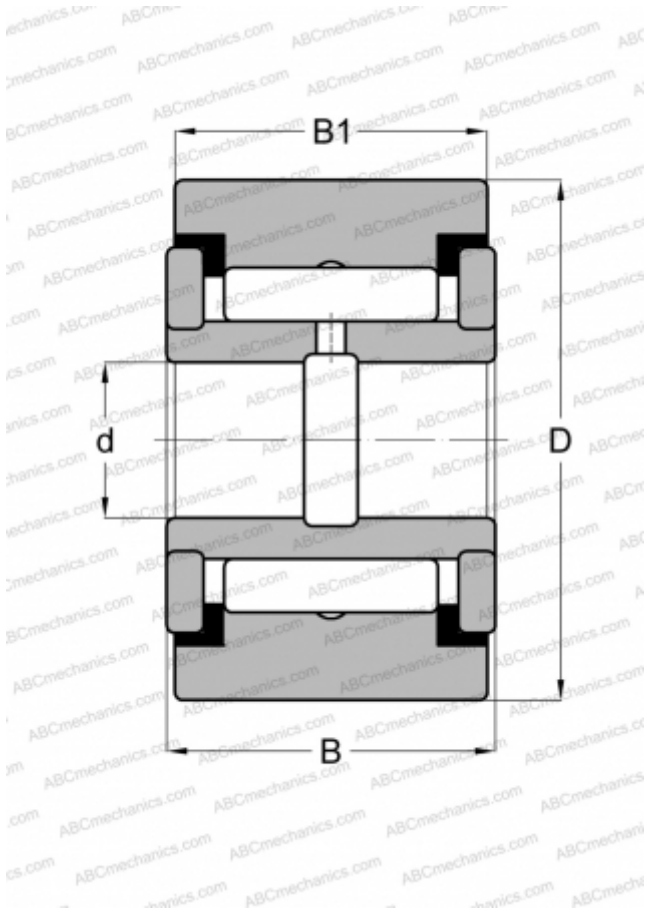

Technical specification

DIMENSIONS, MM

d	15,875
D	50,800
B	33,338
B1	31,750

WEIGHT, KG

0,476

MANUFACTURER

[IKO](#)

INTERCHANGE

ABC	YCRS 32
INA	RF 32 PP
McGill	CYR 2 S
RBC	Y 64 L
SKF	YR 2 X
TORRINGTON	YCRS 32

CALCULATION DATA

Basic dynamic load rating, C	45,700 kN
Basic static load rating, Co	80,600 kN