

YCRS 36 TORRINGTON

Yoke type track roller

TYPE: Roller bearings, Yoke type track rollers, With axial guidance, Full complement needle roller set, sealing rings on both sides, cylindrical outer ring, inch size

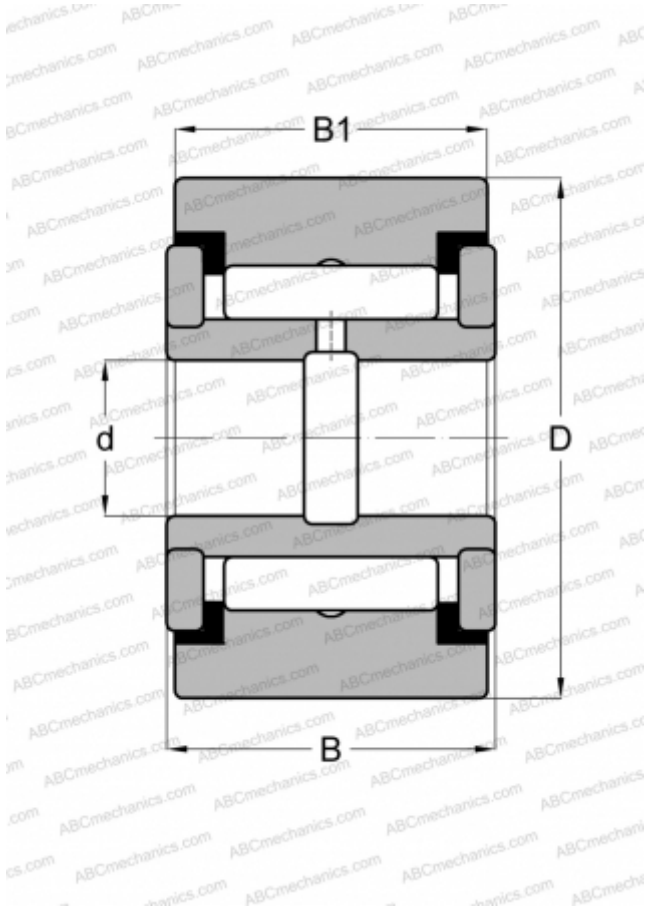

Technical specification

DIMENSIONS, MM

d	15,875
D	57,150
B	33,338
B1	31,750

WEIGHT, KG

0,599

MANUFACTURER

[TORRINGTON](#)

INTERCHANGE

ABC	YCRS 36
INA	RF 36 PP
McGill	CYR 2 1/4 S
RBC	Y 72 L
SKF	YR 2 1/4 X
IKO	CRY 36 VUU