

YCRS 40 ABC

Yoke type track roller

TYPE: Roller bearings, Yoke type track rollers, With axial guidance, Full complement needle roller set, sealing rings on both sides, cylindrical outer ring, inch size

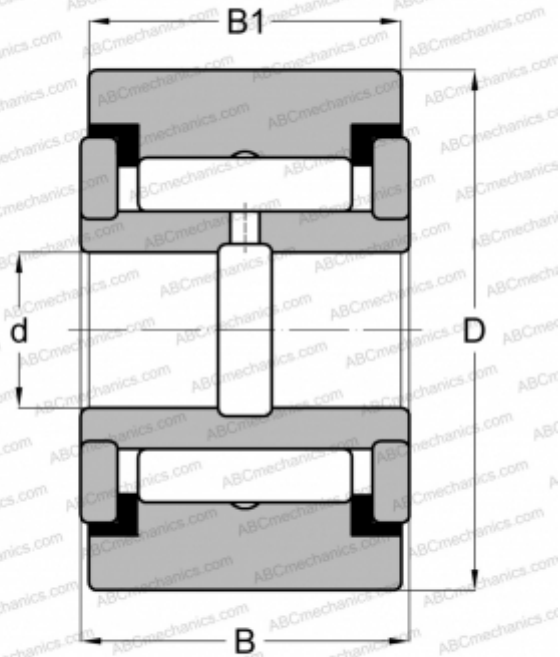

Technical specification

DIMENSIONS, MM

d	19,050
D	63,500
B	39,688
B1	38,100

WEIGHT, KG

0,816

MANUFACTURER

[ABC](#)

INTERCHANGE

INA	RF 40 PP
McGill	CYR 2 1/2 S
RBC	Y 80 L
SKF	YR 2 1/2 X
TORRINGTON	YCRS 40
IKO	CRY 40 VUU