

## CRY 40 VUU IKO

Yoke type track roller

TYPE: Roller bearings, Yoke type track rollers, With axial guidance, Full complement needle roller set, sealing rings on both sides, cylindrical outer ring, inch size

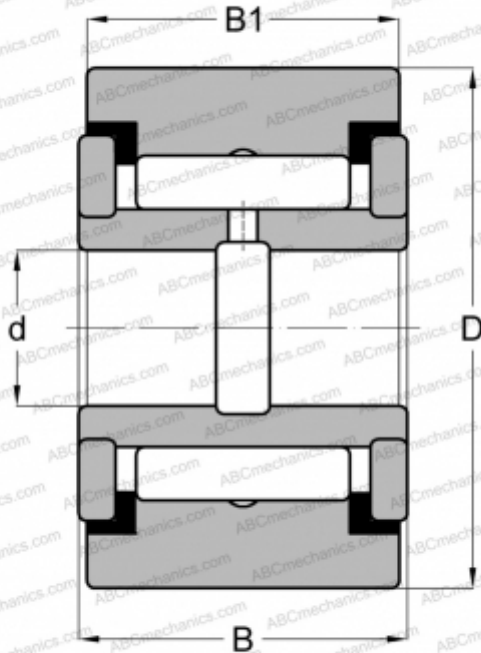

### Technical specification

#### DIMENSIONS, MM

d	19,050
D	63,500
B	39,688
B1	38,100

#### WEIGHT, KG

0,816

#### MANUFACTURER

[IKO](#)

#### INTERCHANGE

ABC	<a href="#">YCRS 40</a>
INA	<a href="#">RF 40 PP</a>
McGill	<a href="#">CYR 2 1/2 S</a>
RBC	<a href="#">Y 80 L</a>
SKF	<a href="#">YR 2 1/2 X</a>
TORRINGTON	<a href="#">YCRS 40</a>

#### CALCULATION DATA

Basic dynamic load rating, C	61,400 kN
Basic static load rating, Co	116,000 kN