

YCRS 44 ABC

Yoke type track roller

TYPE: Roller bearings, Yoke type track rollers, With axial guidance, Full complement needle roller set, sealing rings on both sides, cylindrical outer ring, inch size

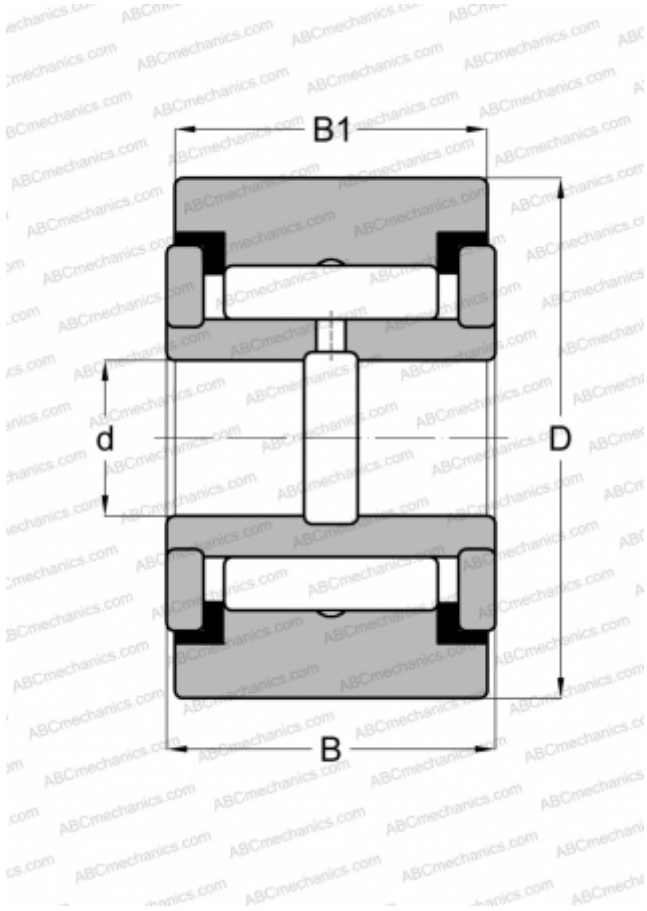

Technical specification

DIMENSIONS, MM

d	19,050
D	69,850
B	39,688
B1	38,100

WEIGHT, KG

1,021

MANUFACTURER

[ABC](#)

INTERCHANGE

INA	RF 44 PP
McGill	CYR 2 3/4 S
RBC	Y 88 L
SKF	YR 2 3/4 X
TORRINGTON	YCRS 44
IKO	CRY 44 VUU