

CRY 44 VUU IKO

Yoke type track roller

TYPE: Roller bearings, Yoke type track rollers, With axial guidance, Full complement needle roller set, sealing rings on both sides, cylindrical outer ring, inch size

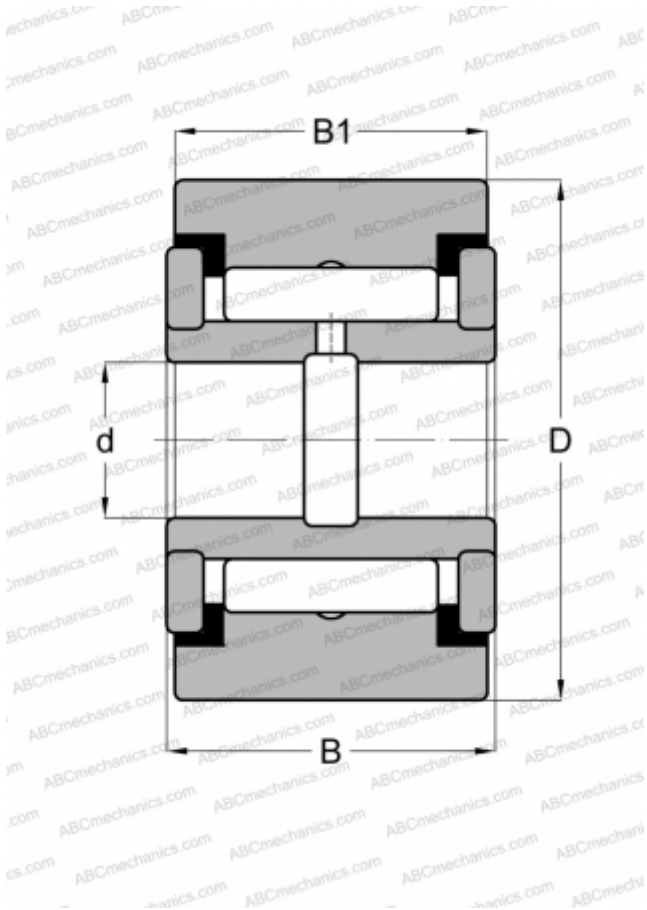

Technical specification

DIMENSIONS, MM

d	19,050
D	69,850
B	39,688
B1	38,100

WEIGHT, KG

1,020

MANUFACTURER

[IKO](#)

INTERCHANGE

ABC	YCRS 44
INA	RF 44 PP
McGill	CYR 2 3/4 S
RBC	Y 88 L
SKF	YR 2 3/4 X
TORRINGTON	YCRS 44

CALCULATION DATA

Basic dynamic load rating, C	61,400 kN
Basic static load rating, Co	116,000 kN