

YCRSC 14 ABC

Yoke type track roller

TYPE: Roller bearings, Yoke type track rollers, With axial guidance, Full complement needle roller set, sealing rings on both sides, inch size

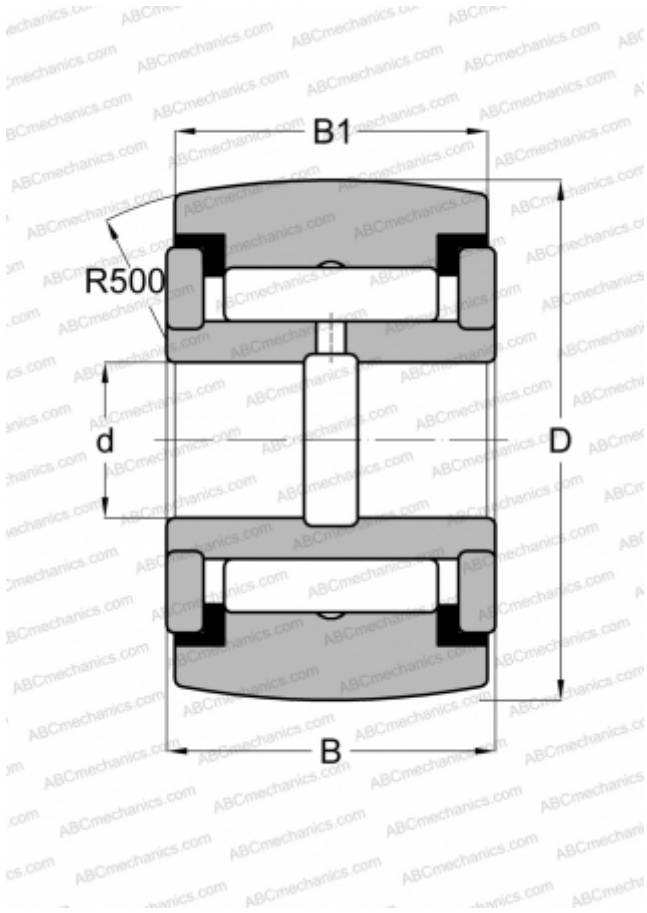

Technical specification

DIMENSIONS, MM

d	6,350
D	22,225
B	14,288
B1	12,700

WEIGHT, KG

0,036

MANUFACTURER

[ABC](#)

INTERCHANGE

INA	RF 14 PPY
McGill	CCYR 7/8 S
RBC	CY 28 L
SMITH BEARING	YR 7/8 XC
TORRINGTON	YCRSC 14
IKO	CRY 14 VUUR