

CRY 18 VUUR IKO

Yoke type track roller

TYPE: Roller bearings, Yoke type track rollers, With axial guidance, Full complement needle roller set, sealing rings on both sides, inch size

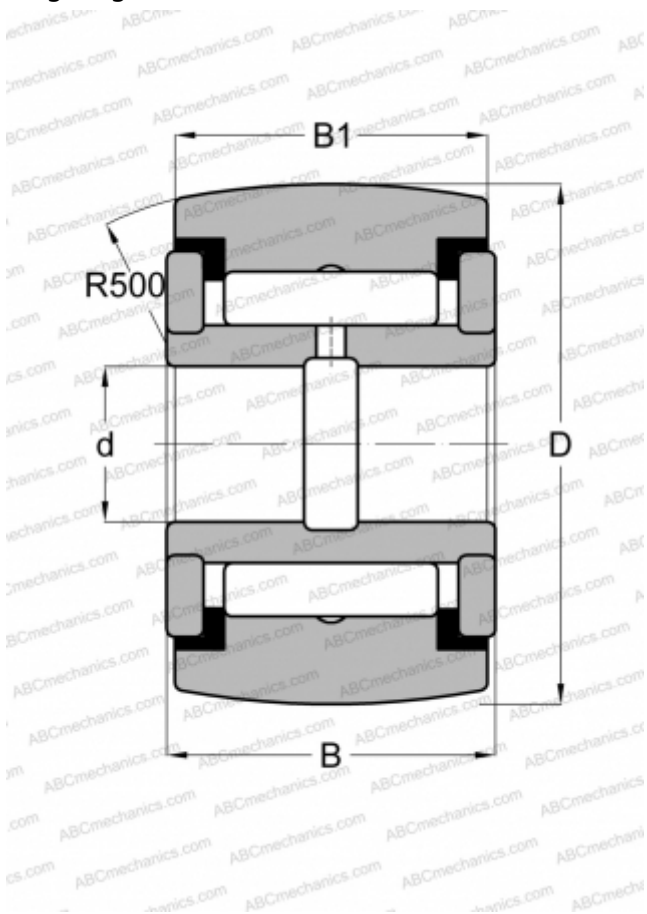

Technical specification

DIMENSIONS, MM

d	7,938
D	28,575
B	17,463
B1	15,875

WEIGHT, KG

0,077

MANUFACTURER

[IKO](#)

INTERCHANGE

ABC	YCRSC 18
INA	RF 18 PPY
McGill	CCYR 1 1/8 S
RBC	CY 36 L
SMITH BEARING	YR 1 1/8 XC
TORRINGTON	YCRSC 18

CALCULATION DATA

Basic dynamic load rating, C	13,100 kN
Basic static load rating, Co	22,700 kN