

CRY 20 VUUR IKO

Yoke type track roller

TYPE: Roller bearings, Yoke type track rollers, With axial guidance, Full complement needle roller set, sealing rings on both sides, inch size

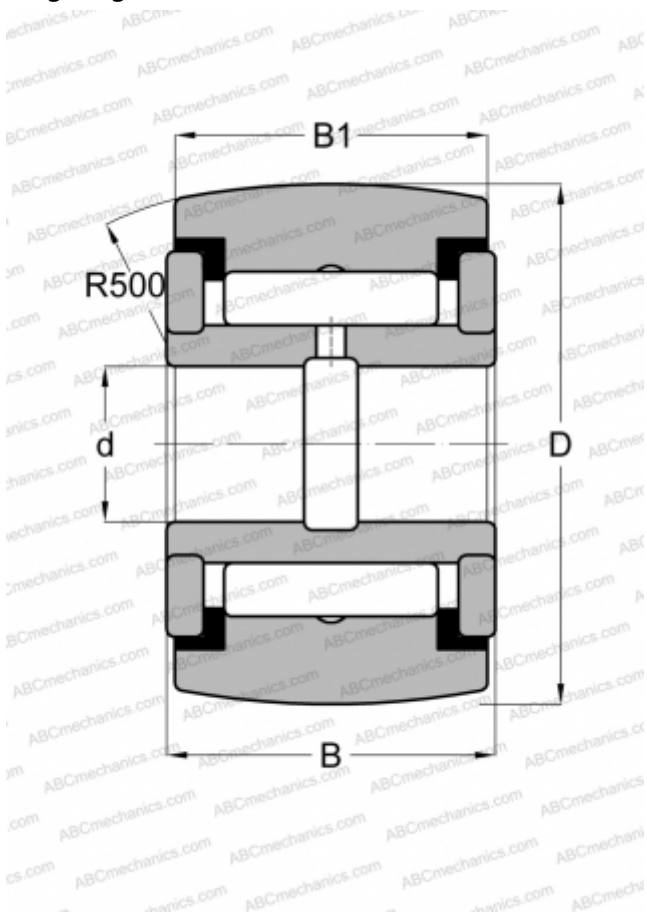

Technical specification

DIMENSIONS, MM

d	9,525
D	31,750
B	20,638
B1	19,050

WEIGHT, KG

0,109

MANUFACTURER

[IKO](#)

INTERCHANGE

ABC	YCRSC 20
INA	RF 20 PPY
McGill	CCYR 1 1/4 S
RBC	CY 40 L
SMITH BEARING	YR 1 1/4 XC
TORRINGTON	YCRSC 20

CALCULATION DATA

Basic dynamic load rating, C	23,600 kN
Basic static load rating, Co	31,700 kN