

CY 44 L RBC

Yoke type track roller

TYPE: Roller bearings, Yoke type track rollers, With axial guidance, Full complement needle roller set, sealing rings on both sides, inch size

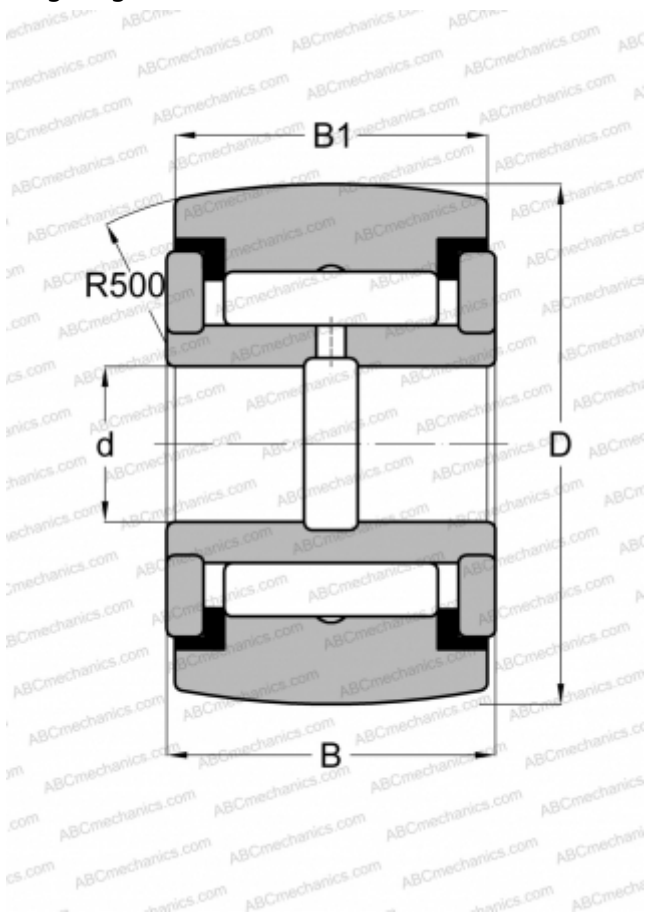

Technical specification

DIMENSIONS, MM

d	9,525
D	34,925
B	20,638
B1	19,050

WEIGHT, KG

0,136

MANUFACTURER

[RBC](#)

INTERCHANGE

ABC	YCRSC 22
INA	RF 22 PPY
McGill	CCYR 1 3/8 S
SMITH BEARING	YR 1 3/8 XC
TORRINGTON	YCRSC 22
IKO	CRY 22 VUUR