

## CRY 24 VUUR IKO

Yoke type track roller

TYPE: Roller bearings, Yoke type track rollers, With axial guidance, Full complement needle roller set, sealing rings on both sides, inch size

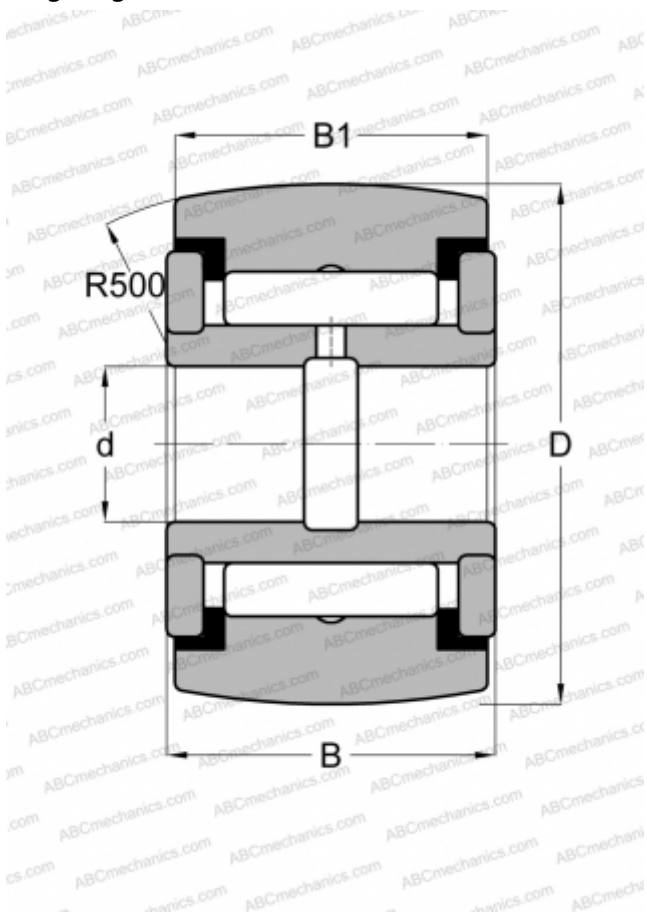

### Technical specification

#### DIMENSIONS, MM

d	11,112
D	38,100
B	23,813
B1	22,225

#### WEIGHT, KG

0,186

#### MANUFACTURER

[IKO](#)

#### INTERCHANGE

ABC	<a href="#">YCRSC 24</a>
INA	<a href="#">RF 24 PPY</a>
McGill	<a href="#">CCYR 1 1/2 S</a>
RBC	<a href="#">CY 48 L</a>
SMITH BEARING	<a href="#">YR 1 1/2 XC</a>
TORRINGTON	<a href="#">YCRSC 24</a>

#### CALCULATION DATA

Basic dynamic load rating, C	28,200 kN
Basic static load rating, Co	40,100 kN