

## CRY 26 VUUR IKO

Yoke type track roller

TYPE: Roller bearings, Yoke type track rollers, With axial guidance, Full complement needle roller set, sealing rings on both sides, inch size

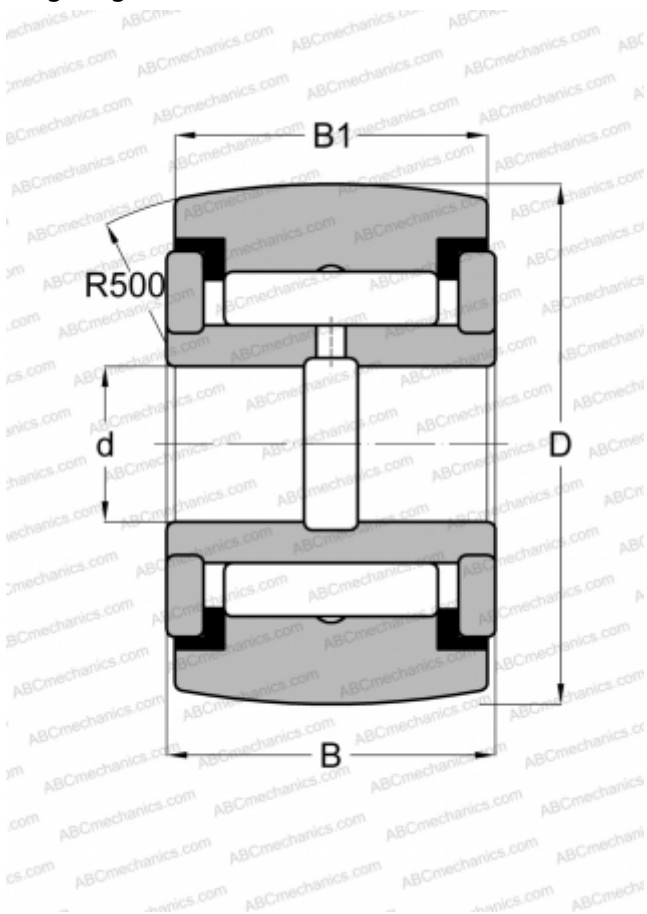

### Technical specification

#### DIMENSIONS, MM

d	11,112
D	41,275
B	23,813
B1	22,225

#### WEIGHT, KG

0,227

#### MANUFACTURER

[IKO](#)

#### INTERCHANGE

ABC	<a href="#">YCRSC 26</a>
INA	<a href="#">RF 26 PPY</a>
McGill	<a href="#">CCYR 1 5/8 S</a>
RBC	<a href="#">CY 52 L</a>
SMITH BEARING	<a href="#">YR 1 5/8 XC</a>
TORRINGTON	<a href="#">YCRSC 26</a>

#### CALCULATION DATA

Basic dynamic load rating, C	28,200 kN
Basic static load rating, Co	40,100 kN