

YR 1 3/4 XC SMITH BEARING

Yoke type track roller

TYPE: Roller bearings, Yoke type track rollers, With axial guidance, Full complement needle roller set, sealing rings on both sides, inch size

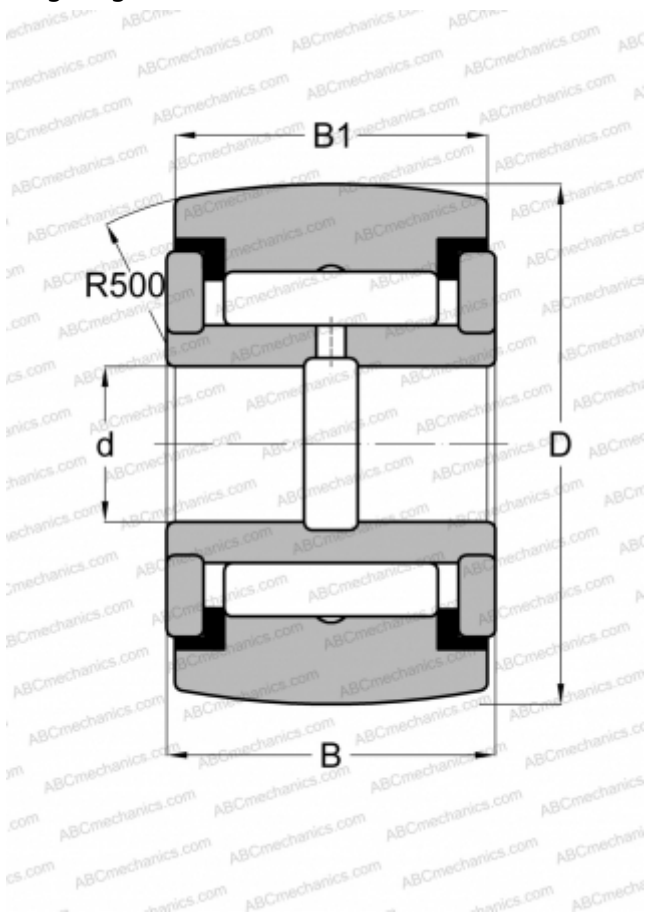

Technical specification

DIMENSIONS, MM

d	12,700
D	44,450
B	26,988
B1	25,400

WEIGHT, KG

0,290

MANUFACTURER

[SMITH BEARING](#)

INTERCHANGE

ABC	YCRSC 28
INA	RF 28 PPY
McGill	CCYR 1 3/4 S
RBC	CY 56 L
TORRINGTON	YCRSC 28
IKO	CRY 28 VUUR