

YCRSC 30 TORRINGTON

Yoke type track roller

TYPE: Roller bearings, Yoke type track rollers, With axial guidance, Full complement needle roller set, sealing rings on both sides, inch size

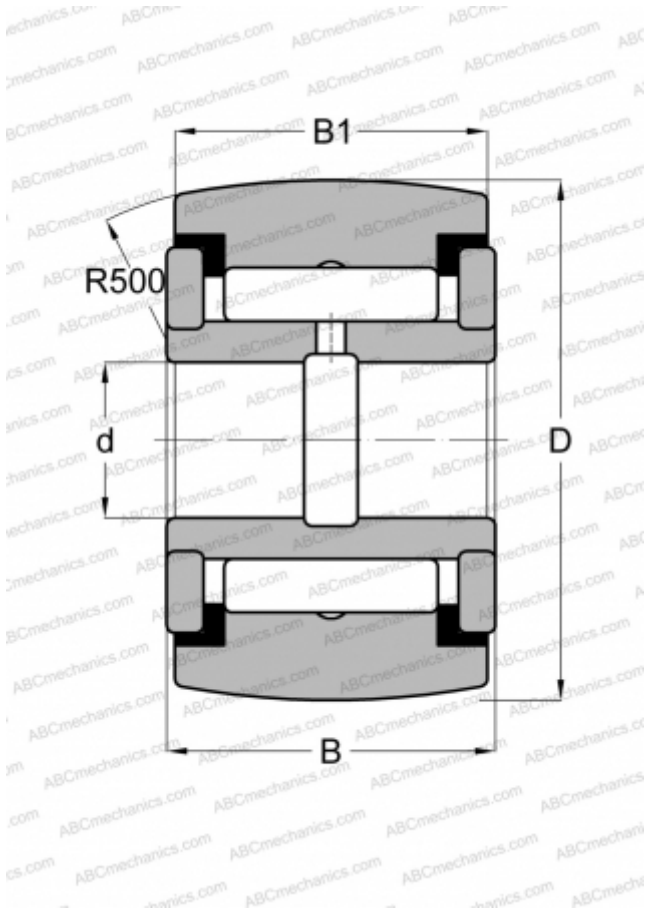

Technical specification

DIMENSIONS, MM

d	12,700
D	47,625
B	26,988
B1	25,400

WEIGHT, KG

0,363

MANUFACTURER

[TORRINGTON](#)

INTERCHANGE

ABC	YCRSC 30
INA	RF 30 PPY
McGill	CCYR 1 7/8 S
RBC	CY 60 L
SMITH BEARING	YR 1 7/8 XC
IKO	CRY 30 VUUR