

CCYR 2 1/4 S McGill

Yoke type track roller

TYPE: Roller bearings, Yoke type track rollers, With axial guidance, Full complement needle roller set, sealing rings on both sides, inch size

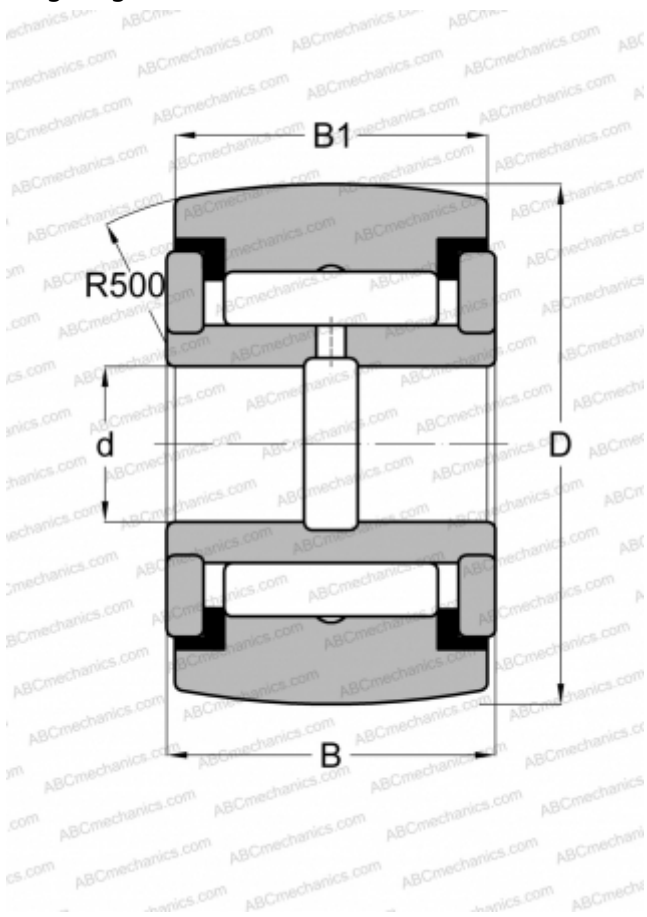

Technical specification

DIMENSIONS, MM

d	15,875
D	57,150
B	33,338
B1	31,750

WEIGHT, KG

0,599

MANUFACTURER

[McGill](#)

INTERCHANGE

ABC	YCRSC 36
INA	RF 36 PPY
RBC	CY 72 L
SMITH BEARING	YR 2 1/4 XC
TORRINGTON	YCRSC 36
IKO	CRY 36 VUUR