

YR 2 1/2 XC SMITH BEARING

Yoke type track roller

TYPE: Roller bearings, Yoke type track rollers, With axial guidance, Full complement needle roller set, sealing rings on both sides, inch size

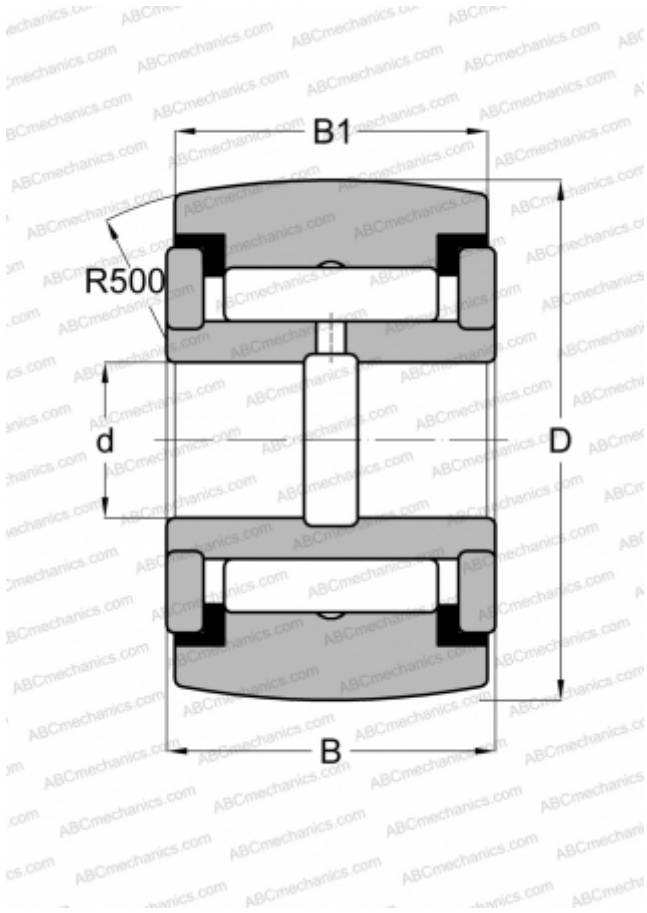

Technical specification

DIMENSIONS, MM

d	19,050
D	63,500
B	39,688
B1	38,100

WEIGHT, KG

0,816

MANUFACTURER

[SMITH BEARING](#)

INTERCHANGE

ABC	YCRSC 40
INA	RF 40 PPY
McGill	CCYR 2 1/2 S
RBC	CY 80 L
TORRINGTON	YCRSC 40
IKO	CRY 40 VUUR