

CY 112 L RBC

Yoke type track roller

TYPE: Roller bearings, Yoke type track rollers, With axial guidance, Full complement needle roller set, sealing rings on both sides, inch size

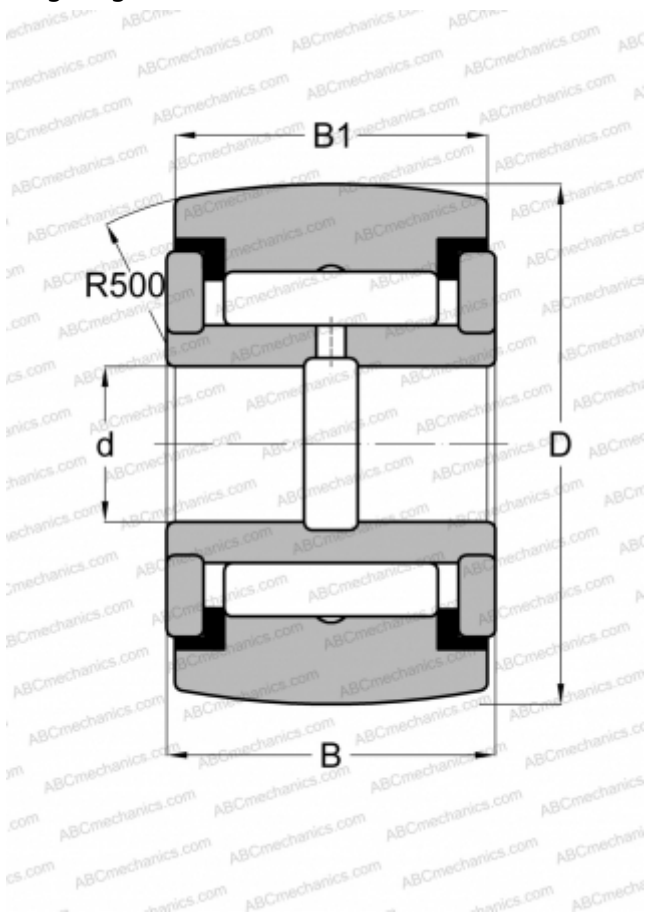

Technical specification

DIMENSIONS, MM

d	28,575
D	88,900
B	52,388
B1	50,800

WEIGHT, KG

2,245

MANUFACTURER

[RBC](#)

INTERCHANGE

ABC	YCRSC 56
INA	RF 56 PPY
McGill	CCYR 3 1/2 S
SMITH BEARING	YR 3 1/2 XC
TORRINGTON	YCRSC 56
IKO	CRY 56 VUUR