

GE 5 E IKO

Spherical plain bearings

TYPE: Plain bearings, Spherical plain bearings and rod ends, Radial spherical plain bearings, Requiring maintenance, Series GE..E/ES

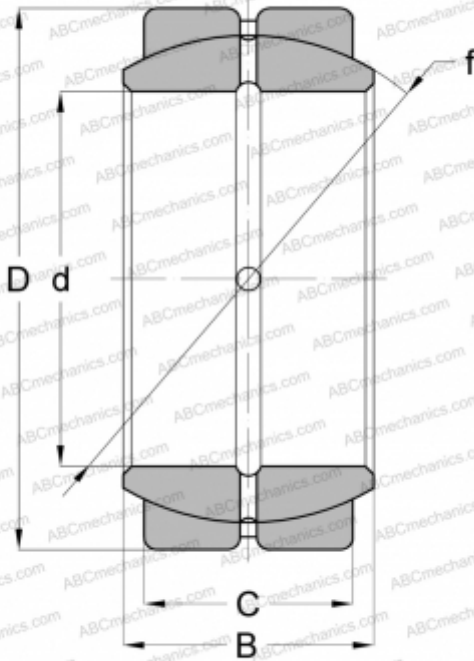

Technical specification

DIMENSIONS, MM

d	5,000
D	14,000
B	6,000
C	4,000

MANUFACTURER

[IKO](#)

INTERCHANGE

ABC	GE 5 E
FAG	GE 5 E
SKF	GE 5 E

CALCULATION DATA

Basic dynamic load rating, C	3,920 kN
Basic static load rating, Co	23,500 kN