

GE 110 GS IKO

Spherical plain bearings

TYPE: Plain bearings, Spherical plain bearings and rod ends, Radial spherical plain bearings, Requiring maintenance, Series GEH..ES, GE..FO, GE..G(S)

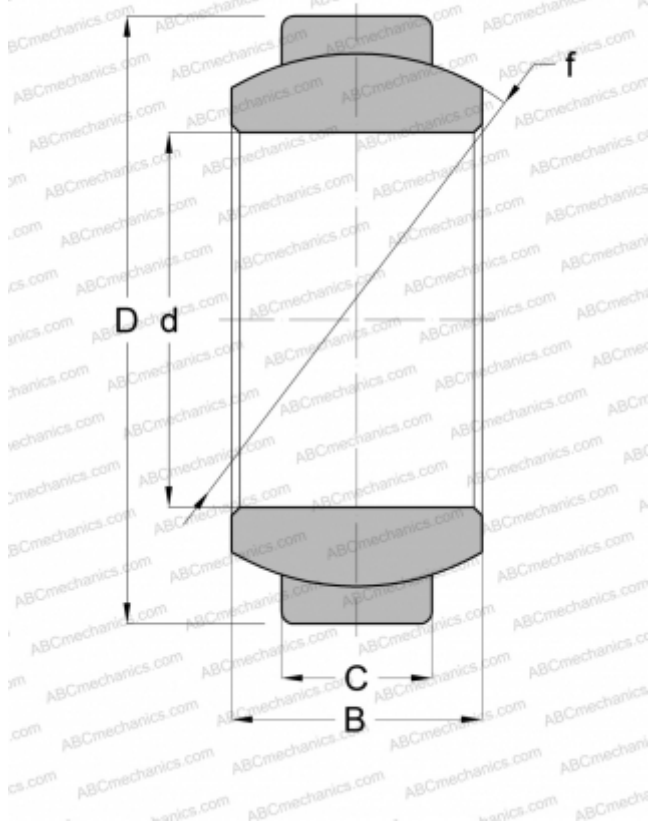

Technical specification

DIMENSIONS, MM

d	110,000
D	180,000
B	100,000
C	70,000

WEIGHT, KG

9,700

MANUFACTURER

[IKO](#)

INTERCHANGE

ABC	GE 110 GS
-----	---------------------------

CALCULATION DATA

Basic dynamic load rating, C	1100,000 kN
Basic static load rating, Co	6590,000 kN