

GE 140 GS IKO

Spherical plain bearings

TYPE: Plain bearings, Spherical plain bearings and rod ends, Radial spherical plain bearings, Requiring maintenance, Series GEH..ES, GE..FO, GE..G(S)

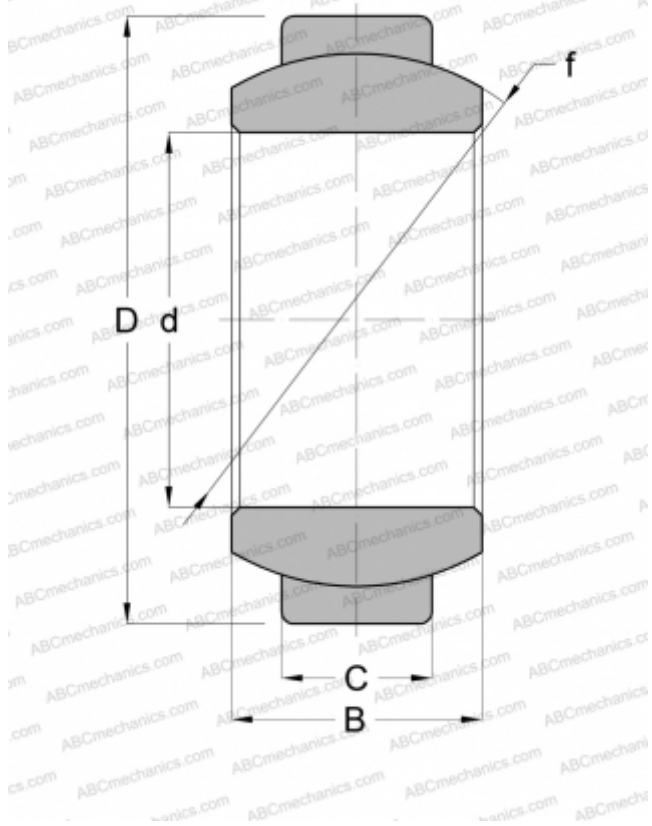

Technical specification

DIMENSIONS, MM

d	140,000
D	230,000
B	130,000
C	80,000

WEIGHT, KG

19,200

MANUFACTURER

[IKO](#)

INTERCHANGE

ABC	GE 140 GS
-----	---------------------------

CALCULATION DATA

Basic dynamic load rating, C	1570,000 kN
Basic static load rating, Co	9410,000 kN