

B12-L RBC

Spherical plain bearings

TYPE: Plain bearings, Spherical plain bearings and rod ends, Radial spherical plain bearings, Requiring maintenance, Inch size, series GEZ..ES, GE..ZO, SBB

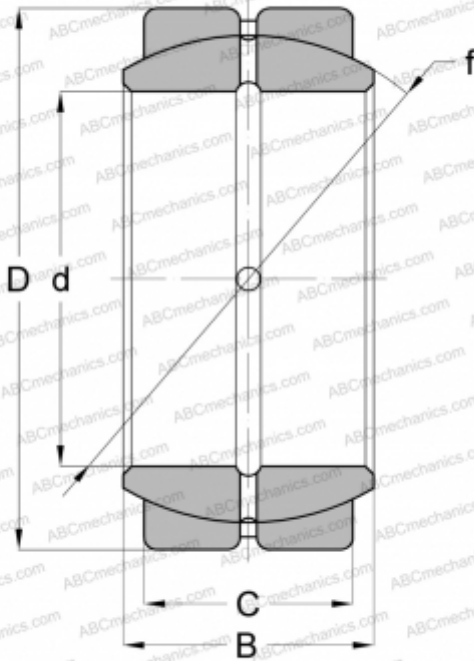

Technical specification

DIMENSIONS, MM

d	19,050
D	31,750
B	16,668
C	14,288

WEIGHT, KG

0,054

MANUFACTURER

[RBC](#)

INTERCHANGE

ABC	GEZ 012 ES
INA	GE 19 ZO
SKF	GEZ 012 ES
TORRINGTON	7 SF 12
IKO	SBB 12