

SBB 12 IKO

Spherical plain bearings

TYPE: Plain bearings, Spherical plain bearings and rod ends, Radial spherical plain bearings, Requiring maintenance, Inch size, series GEZ..ES, GE..ZO, SBB

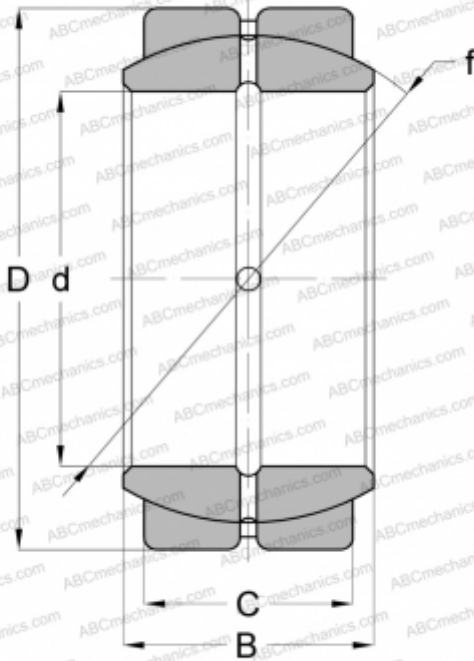

Technical specification

DIMENSIONS, MM

d	19,050
D	31,750
B	16,660
C	14,270

WEIGHT, KG

0,057

MANUFACTURER

[IKO](#)

INTERCHANGE

ABC	GEZ 012 ES
INA	GE 19 ZO
RBC	B12-L
SKF	GEZ 012 ES
TORRINGTON	7 SF 12

CALCULATION DATA

Basic dynamic load rating, C	38,500 kN
Basic static load rating, Co	231,000 kN