

PB 5 ABC

Spherical plain bearings

TYPE: Plain bearings, Spherical plain bearings and rod ends, Radial spherical plain bearings, Requiring maintenance, Series PB

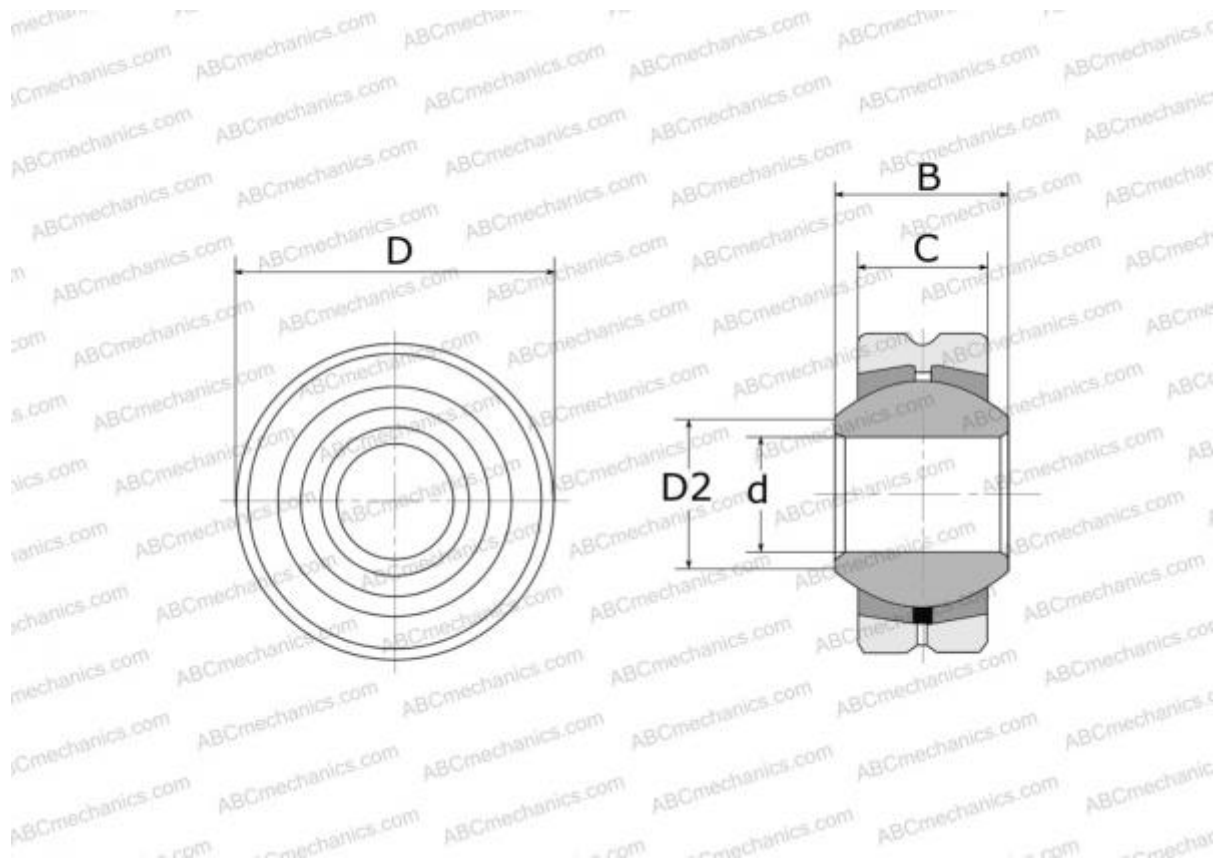

Technical specification

DIMENSIONS, MM

d	5,000
D	16,000
D2	7,700
B	8,000
C	6,000

WEIGHT, KG 0,009

MANUFACTURER [ABC](#)

INTERCHANGE

IKO	PB 5
HIRSCHMANN	SS 5